



Design Example Report

Title	<i>60W DC-DC Power Supply using DPA426R</i>
Specification	Input: 36 - 72VDC Output: 12V / 5A
Application	Distributed Power Architectures
Author	Power Integrations Applications Department
Document Number	DER-20
Date	March 30, 2004
Revision	1.0

Summary and Features

This report describes a design for Distributed Power Architecture power supply, featuring the following:

- Uses DPA426R
- 36-72 VDC input
- 12V / 60 W output
- Low component count
- Integrated fault protection

The products and applications illustrated herein (including circuits external to the products and transformer construction) may be covered by one or more U.S. and foreign patents or potentially by pending U.S. and foreign patent applications assigned to Power Integrations. A complete list of Power Integrations' patents may be found at www.powerint.com.

Power Integrations, Inc.

5245 Hellyer Avenue, San Jose, CA 95138 USA.
Applications Hotline: Tel: +1 408 414 9660 Fax: +1 408 414 9760
www.powerint.com

Table Of Contents

1	Introduction	4
2	Power Supply Specification.....	4
3	Schematic	5
4	Circuit Description	6
4.1	Primary Side Circuit	6
4.2	Output Rectification.....	6
4.3	Output Feedback	6
5	PCB Layout.....	7
6	Bill Of Materials	8
7	Transformer Specification	9
7.1	Electrical Specifications	9
7.2	Materials	9
7.3	Transformer Build Diagram.....	10
7.4	Transformer Construction	10
8	Transformer Spreadsheets	11
9	Performance Data	13
9.1	Efficiency.....	13
9.2	Regulation.....	14
9.2.1	Load.....	14
9.2.2	Line.....	15
10	Waveforms	16
10.1	Drain Voltage, Normal Operation	16
10.2	Output Voltage Start-up Profile	18
10.3	Output Ripple Measurements	19
10.3.1	Ripple Measurement Technique	19
10.3.2	Measurement Results.....	20
11	Revision History.....	21



List Of Figures

Figure 1 - Schematic	5
Figure 2 - Printed Circuit Layout	7
Figure 3 - Transformer Diagram	9
Figure 4- Transformer construction.....	10
Figure 5 - Efficiency vs. Load Current, Room Temperature	13
Figure 6- Load Regulation, Room Temperature	14
Figure 7 - Line Regulation, Room Temperature	15
Figure 8 - 60VDC No Load- VDS, 20V / div.....	16
Figure 9 – 60VDC I = 5A - VDS 20V / div.....	16
Figure 10 - 48VDC I = 2.5A - VDS, 50V / div.....	17
Figure 11 - 36VDC I = 4A - VDS, 50V / div.....	17

List Of Tables

Table 1 – Power Supply Specification	4
Table 2 - Flyback Converter Bill Of Materials	8
Table 3 – Transformer BOM.....	9
Table 4 – Transformer Spreadsheet.....	12

Important Notes:

Although this board is designed to satisfy safety isolation requirements, the engineering prototype has not been agency approved. Therefore, all testing should be performed using an isolated source to provide power to the prototype board.

Design Reports contain a power supply design specification, schematic, bill of materials, and transformer documentation. Performance data and typical operation characteristics are included. Typically only a single prototype has been built.



1 Introduction

This document is an engineering report describing a single output Flyback converter employing the DPA426R - an integrated IC comprising a high voltage MOSFET and a fully featured PWM controller. The input voltage range is 36 to 72VDC providing a regulated +12V at 5A.

This document contains the power supply specification, schematic, and bill of materials, transformer documentation, printed circuit layout, and performance data.

2 Power Supply Specification

Description	Symbol	Min	Typ	Max	Units	Comment
Input Voltage No-load Input Power (60V _{DC})	V _{IN}	36	48	72 1	V _{DC} W	
Output Output Voltage 1 Output Ripple Voltage 1 Output Current 1 Total Output Power Continuous Output Power Peak Output Power	V _{OUT1} V _{RIPPLE1} I _{OUT1} P _{OUT} P _{OUT_PEAK}	12.1	12.75	13.4 50 5 60 75	V mV A W W	± 5% 20 MHz Bandwidth
Efficiency	η	82			%	Measured at Max. P _{OUT} , 25 °C
Ambient Temperature	T _{AMB}	0		40	°C	Free convection, Sea level

Table 1 – Power Supply Specification



3 Schematic

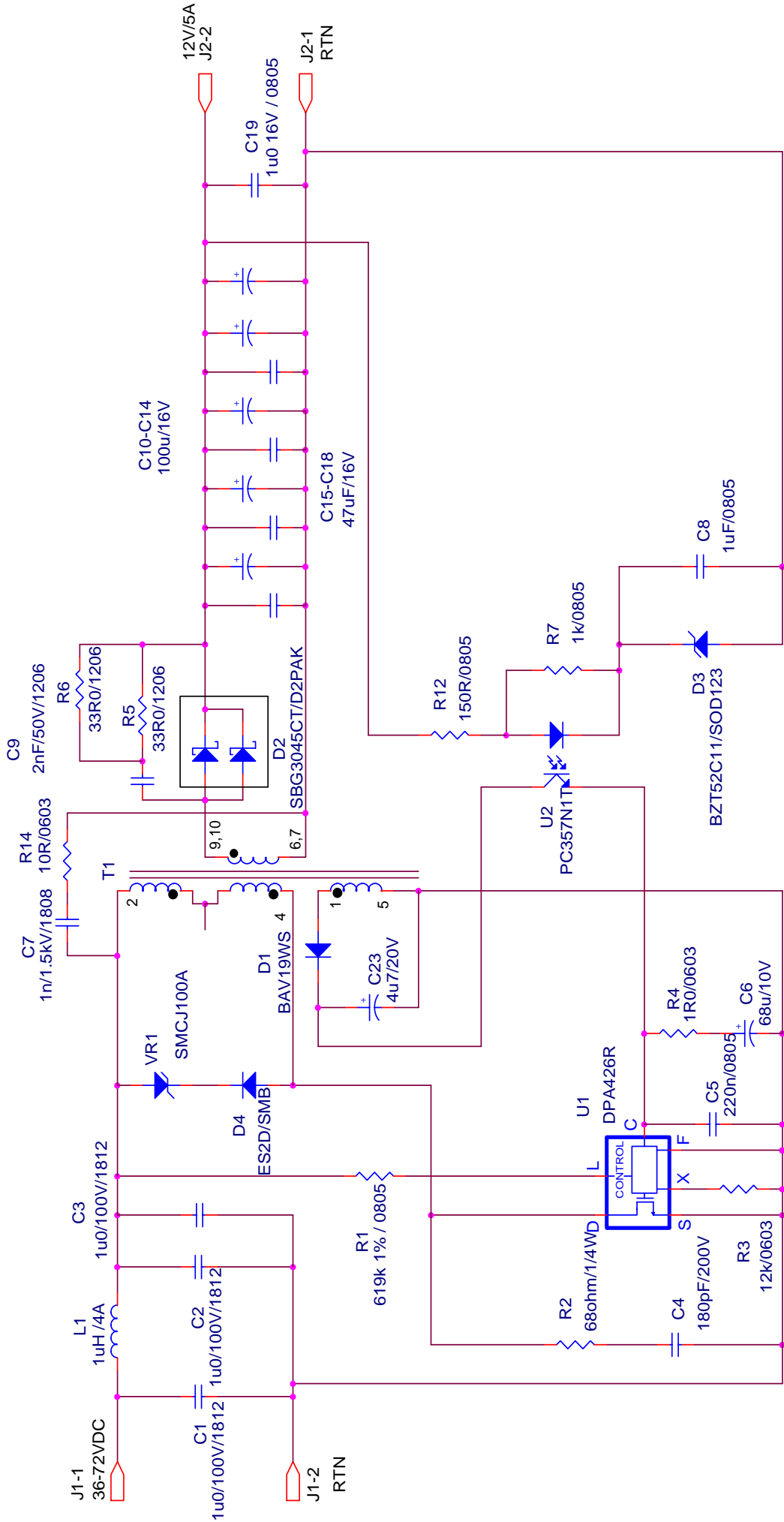

Figure 1 - Schematic

4 Circuit Description

4.1 Primary Side Circuit

Figure 1 shows a single-ended Flyback converter using the DPA426R. The circuit is designed for 36 V to 72 V input range and provides a single +12V @ 5A output. C1 and L1 provide input filtering. C2 and C3 bypass the DC rail. The DC rail is applied to the primary winding of T1. The other side of the transformer primary is driven by the integrated MOSFET in U1. D4 and VR1 clamp the maximum voltage transients at the Drain of U1 caused by energy stored in the leakage inductance of the transformer.

R1 is used to set the low line turn-on threshold to approximately 33 V, and also sets the over-voltage shutdown level to approximately 88 V. C5 bypasses the U1 control pin, and provides the peak current necessary for driving the **DPA-Switch** internal MOSFET. C6 has three functions. It provides the energy required by U1 during startup, sets the auto-restart frequency during fault conditions, and also reduces the gain of U1 as a function of frequency. R4 adds a zero to stabilize the power supply control loop. R2 and C4 are snubber components that reduce high frequency oscillations on the Drain-source voltage waveform.

4.2 Output Rectification

The output of T1 is rectified and filtered by D2 and C10-C18. An auxiliary Flyback winding on T1 powers U1 during normal operation. This winding delivers energy during the off time of U1 (e.g. the flyback period), with an output voltage proportional to the supply output voltage. The turns-ratio of T1 sets the output voltage of the auxiliary winding to approximately 12 V. D1 and C23 rectify and filter the auxiliary winding output.

4.3 Output Feedback

Zener Diode (D3) and the opto-coupler (U3) photo-diode voltage drop set the output voltage. R12 and R7 bias the opto-coupler and zener diode. The opto-coupler output also provides power to U1 during normal operating conditions.



5 PCB Layout

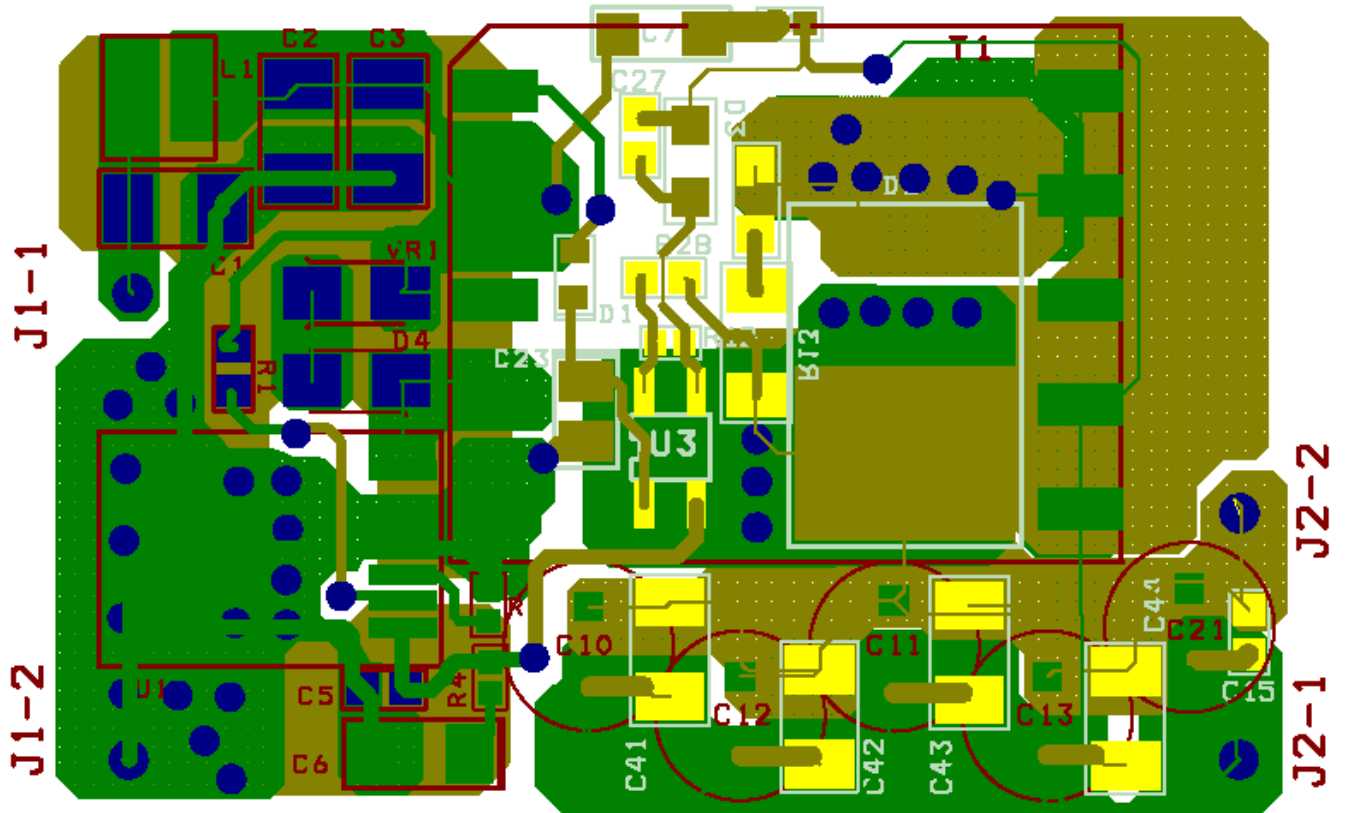

Figure 2 - Printed Circuit Layout.



6 Bill Of Materials

Flyback Converter Bill Of Materials

Item	Qty	Reference	Description	Manufacturer	Part Number
1	3	C1-C3	1u0/100V/1812		
2	1	C4	180pF/200V		
3	1	C5	220n/0805		
4	1	C6	68u/10V		
5	1	C7	1n/1.5kV/1808		
6	2	C8, C19	1uF/0805		
7	1	C9	2.2nF/50V/1206		
8	1	C15	1u0 16V / 0805		
9	1	C23	4u7/20V		
10	5	C10-C14	100u/16V	Sanyo	16SA100M
11	4	C15-C18	47uF/16V	TDK	C5750X5R1C476M
12	1	D1	BAV19WS	Diodes, Inc.	
13	1	D2	SBG3045CT/D2PAK	Diodes, Inc.	
14	1	D3	BZT52C11/SOD123	Diodes, Inc.	
15	1	D4	ES2D/SMB	Diodes, Inc.	
16	1	L1	1uH /4A		
17	1	R1	619k 1% / 0805		
18	1	R2	68ohm/1/4W		
19	1	R3	12k/0603		
20	1	R4	1R0/0603		
21	2	R5, R6	33R0/1206		
22	1	R7	1k/0805		
23	1	R12	150R/0805		
24	1	R14	10R/0603		
25	1	T1	Custom Flyback Transformer		
26	1	U1	DPA426R	Power Integrations	
27	1	U2	PC357N1T	Sharp	
28	1	VR1	SMCJ100A	Diodes, Inc.	

Table 2 - Flyback Converter Bill Of Materials



7 Transformer Specification

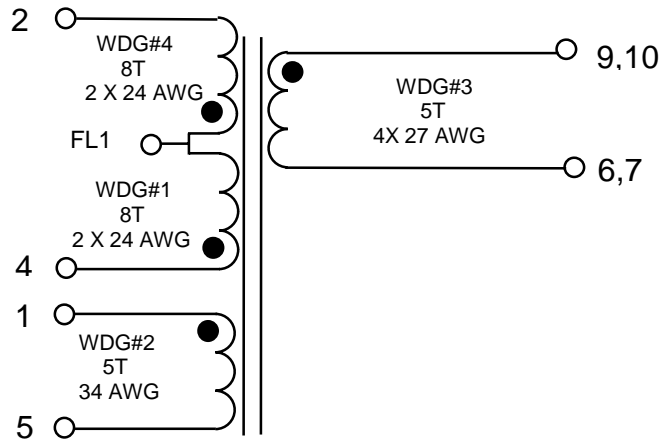

Figure 3 - Transformer Diagram.

7.1 Electrical Specifications

Electrical Strength	1 second, from Pins 1-4 to Pins 5-8	1500 VDC
Creepage	Between Pins 1-4 and Pins 5-8	N/A
Primary Inductance	Pins 1,4, all other windings open, measured at 400KHz, 400mVRMS	21 μ H, ± 10 %
Resonant Frequency	Pins 1,4, all other windings open	3.0 MHz (Min.)
Primary Leakage Inductance	Pins 1,4, with Pins 5-8 shorted, measured at 400KHz, 400mVRMS	1 μ H (Max.)

7.2 Materials

Item	Description
[1]	Core: EFD25-3F3 or equivalent gap for A_L of 84 nH/T ²
[2]	Bobbin: 10 pin surface mount
[3]	Magnet Wire: #27 AWG Double Coated
[4]	Magnet Wire: #34 AWG Double Coated
[5]	Magnet Wire: #24 AWG Double Coated
[6]	Tape, Polyester
[7]	Varnish

Table 3 – Transformer BOM



7.3 Transformer Build Diagram

7.4 Transformer Construction

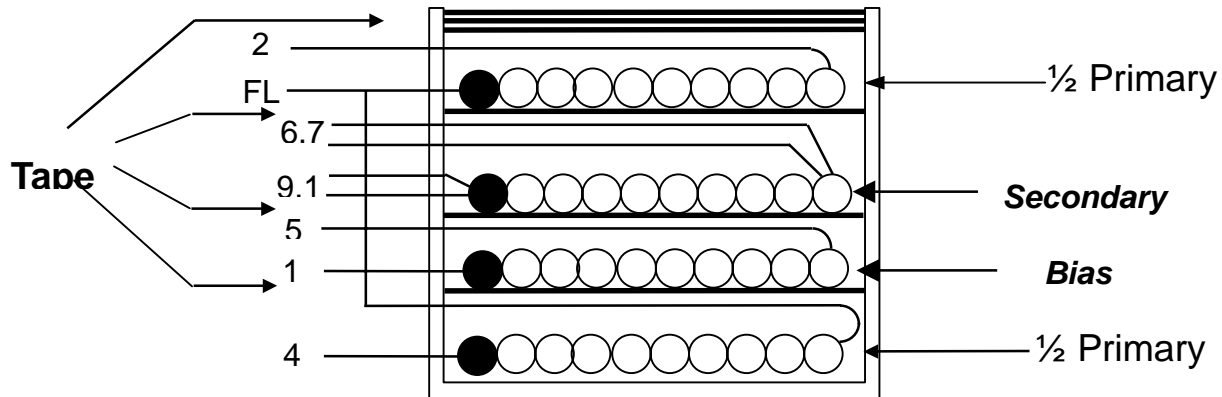

Figure 4– Transformer construction

1/2 Primary	Start at Pin 4. Wind 8 bifiliar turns of item [5]. Finish on Exit-finish lead at bobbin flange slot on primary side of bobbin, leaving 1" lead length.
Basic Insulation	Use one layer of item [6] for basic insulation.
Bias Winding	Start at Pin 1. Wind 5 turns of item [4] Finish on Pin 5.
Basic Insulation	Use one layer of item [6] for basic insulation.
Secondary Winding	Start at Pins 9 and 10. Wind 5 quadrifiliar turns of item [3] Finish on Pins 6 and 7.
Basic Insulation	Use one layer of item [6] for basic insulation.
1/2 Primary	Start in bobbin flange slot on primary side of transformer leave 1" lead length at start. Wind 8 bifiliar turns of item [5]. Finish on Pin 2.
Outer Wrap	Wrap windings with 3 layers of tape [item 5].
Flying Lead Finish	Twist start of winding 4 together with finish of winding 2. Tin and trim to 1/8" length (FL1).
Final Assembly	Assemble and secure core halves. Varnish and impregnate (item [7]).



8 Transformer Spreadsheets

A	B	D	F	G	I
	INPUT	INFO	OUTPUT	UNITS	
DPASwitch_Flyback_Rev_1e_090302; Copyright Power Integrations Inc. 2002					DPASwitch_Flyback_090302 - Continuous/Discontinuous mode Spreadsheet. Copyright 2002 Power Integrations
ENTER APPLICATION VARIABLES					
VDCMIN	36			Volts	12V/5A
VDCMAX	72			Volts	Minimum DC Input Voltage
VO	12			Volts	Maximum DC Input Voltage
PO	60			Watts	Output Voltage
n	0.83				Output Power
Z			0.7		Efficiency Estimate
VB	12			Volts	Loss Allocation Factor, (0.7 Recommended)
					Bias Voltage
UV AND OV PARAMETERS					
VUVOFF		min	max		
VUVON		29.3	32.4	Volts	Minimum undervoltage On-Off threshold
VOVON		31.5	33.9	Volts	Maximum undervoltage Off-On threshold (turn-on)
VOVOFF		73.1	-	Volts	Minimum overvoltage Off-On threshold
RL			92.4	Volts	Maximum overvoltage On-Off threshold (turn-off)
			603.1	k-Chrms	Line Sense Resistor
ENTER DPASWITCH VARIABLES					
DPASWITCH	dpa426			16VDC	36VDC
Chosen Device	DPA426		Power Out	43W	100W
ILIMITMAX	6.5	7.5		Amps	From DPASWITCH Data Sheet
Frequency	f			Hertz	Enter 'f' for fs = 400KHz and 'L' for fs = 300KHz
fs	400000			Hertz	DPASWITCH Switching Frequency
VOR	41	Warning	41	Volts	Reflected Output Voltage not recommended above 40V. Reduce VOR
KI	1.00		1		Current Limit Reduction Factor
ILIMITEXT			6.500	Amps	Minimum External Current limit
RX			-	k-Chrms	Resistor from X pin to source to set external current limit
VDS	2.5			Volts	DPASWITCH on-state Drain to Source Voltage
VD	0.5			Volts	Output Winding Diode Forward Voltage Drop
VDB	0.7			Volts	Bias Winding Diode Forward Voltage Drop
KRPIKDP	0.50				Ripple to Peak Current Ratio (0.2 < KRP < 1.0 ; 1.0< KDP<6.0)
ENTER TRANSFORMER CORE/CONSTRUCTION VARIABLES					
Core Type	efd25				
Core Manuf					
Bobbin Manuf					
Core		efd25		PIN:	efd25-3F3-Exxx-xx
Bobbin		efd25_Bobbin		PIN:	52.2
AE			0.58	cm ²	Core Effective Cross Sectional Area
LE			5.7	cm	Core Effective Path Length
AL			2000	nH/T ²	Unapprop Core Effective Inductance
BW			16.4	mm	Bobbin Physical Winding Width
M	0			mm	Safety Margin Width (Half the Primary to Secondary Creepage Distance)
L	2				Number of Primary Layers
NS	5				Number of Secondary Turns

Transformer spreadsheet continued...

CURRENT WAVEFORM SHAPE PARAMETERS			
D _{MAX}	0.55		Maximum Duty Cycle
I _{AVG}	2.01 Amps		Average Primary Current
I _P	4.86 Amps		Peak Primary Current
I _R	2.43 Amps		Primary Ripple Current
I _{RMS}	2.76 Amps		Primary RMS Current
TRANSFORMER PRIMARY DESIGN PARAMETERS			
L _P	19 uHenries		Primary Inductance
N _P	16		Primary Winding Number of Turns
N _B	5		Bias Winding Number of Turns
AL _G	72 nH/T ²		Gapped Core Effective Inductance
B _P	1320 Gauss		Peak Flux density during transients (Limit to 4000 Gauss)
B _M	988 Gauss		Peak Flux density ~2000 Gauss, A smaller core may be used
B _{AC}	247 Gauss		AC Flux Density for Core Loss Curves (0.5 X Peak to Peak)
l _r	1564		Relative Permeability of Ungapped Core
L _G	0.98 mm		Gap Length (L _g >> 0.051 mm)
B _{WE}	32.8 mm		Effective Bobbin Width
TRANSFORMER SECONDARY DESIGN PARAMETERS			
I _{SP}	15.96 Amps		Peak Secondary Current
I _{SRMS}	8.17 Amps		Secondary RMS Current
I _O	5.00 Amps		Power Supply Output Current
I _{RIPPLE}	6.46 Amps		Output Capacitor RMS Ripple Current
VOLTAGE STRESS PARAMETERS			
V _{DRAIN}	178 Volts		Maximum Drain Voltage (Includes Effect of Leakage Inductance)
V _{VS}	34 Volts		Output Rectifier Maximum Peak Inverse Voltage
V _{VB}	34 Volts		Bias Rectifier Maximum Peak Inverse Voltage
ADDITIONAL OUTPUTS			
V _{OUT2}	Volts		Auxiliary Output Voltage
V _{D_OUT2}	Volts		Auxiliary Diode Forward Voltage Drop
N _{_OUT2}	0.00		Auxiliary Number of Turns

Table 4 – Transformer Spreadsheet

9 Performance Data

All measurements performed at room temperature.

9.1 Efficiency

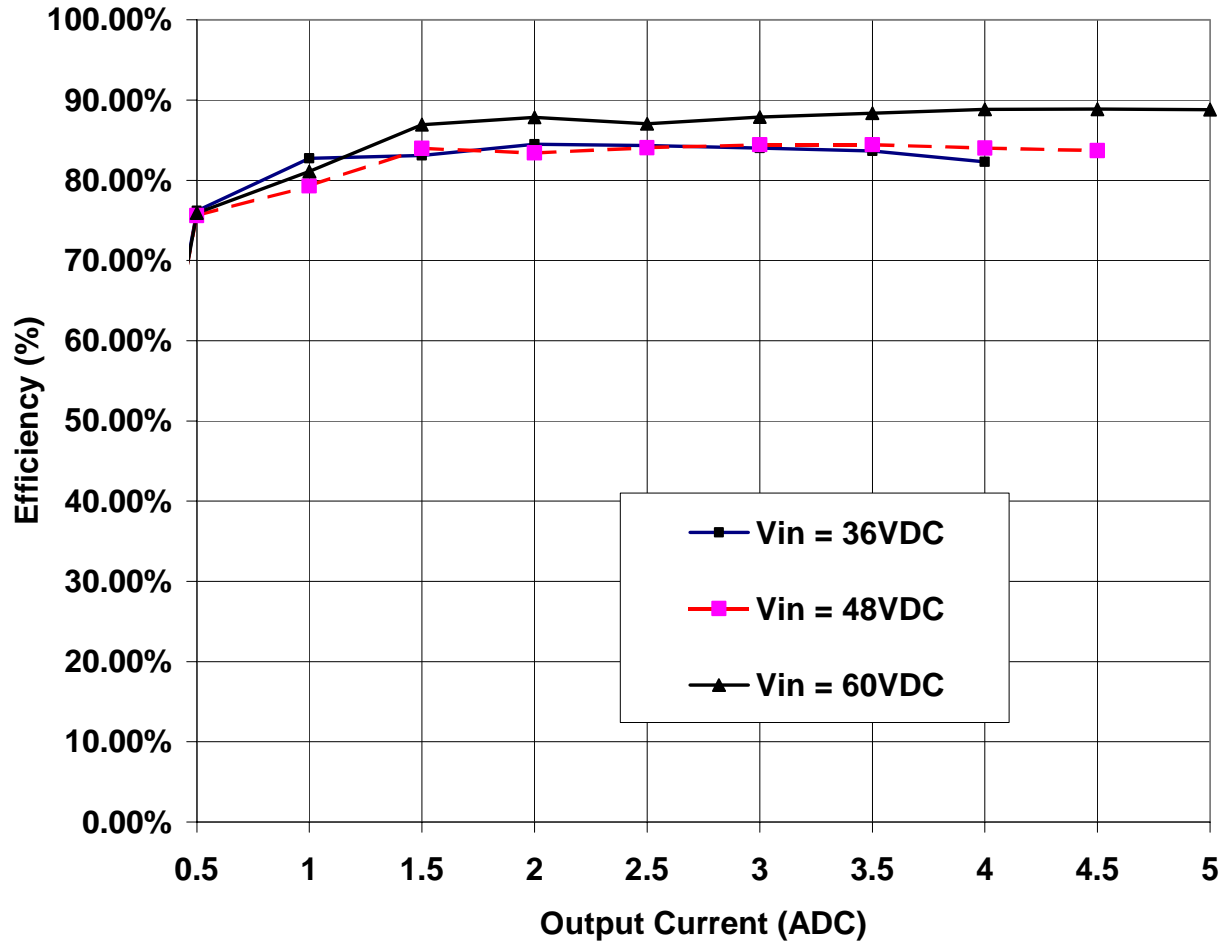

Figure 5 - Efficiency vs. Load Current, Room Temperature



9.2 Regulation

9.2.1 Load

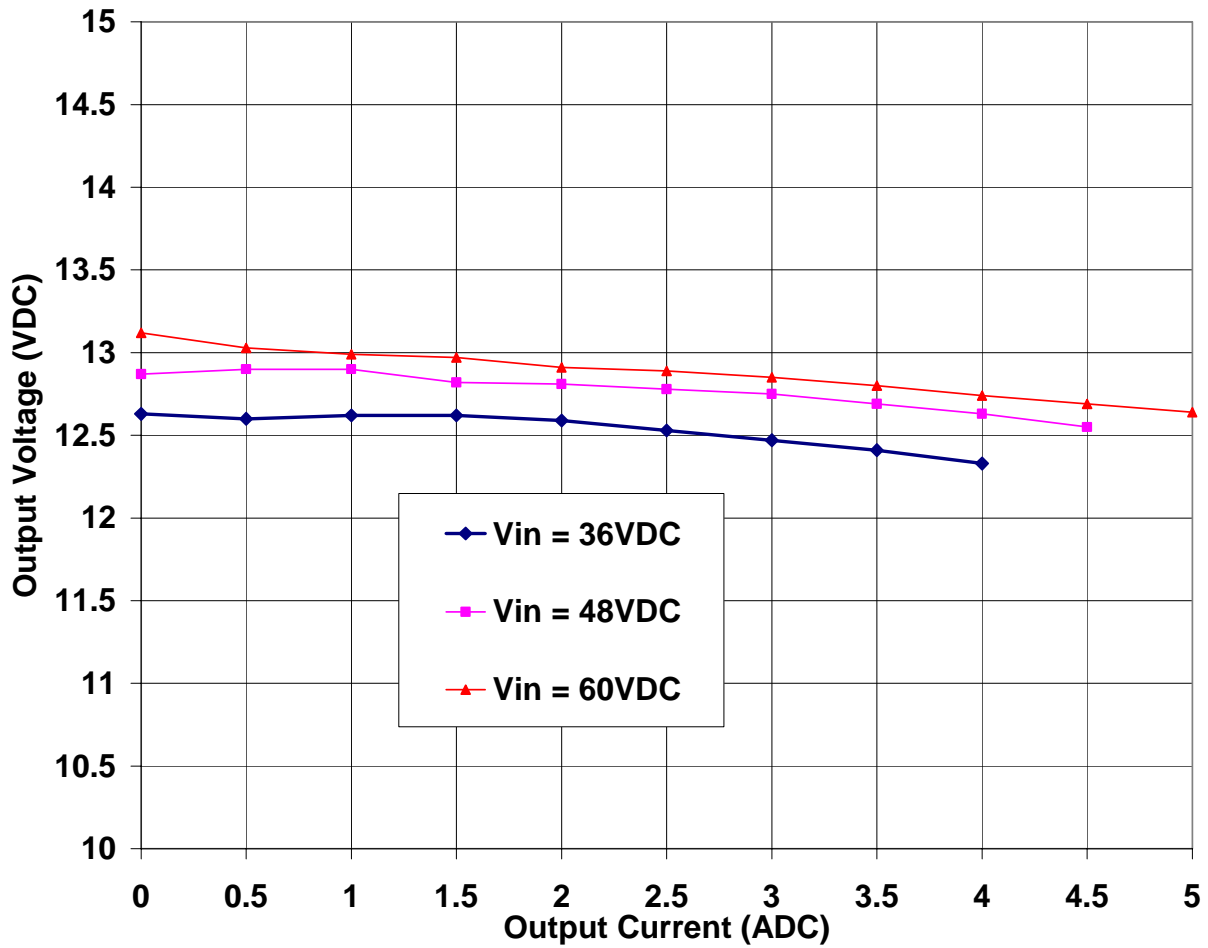

Figure 6- Load Regulation, Room Temperature



9.2.2 Line

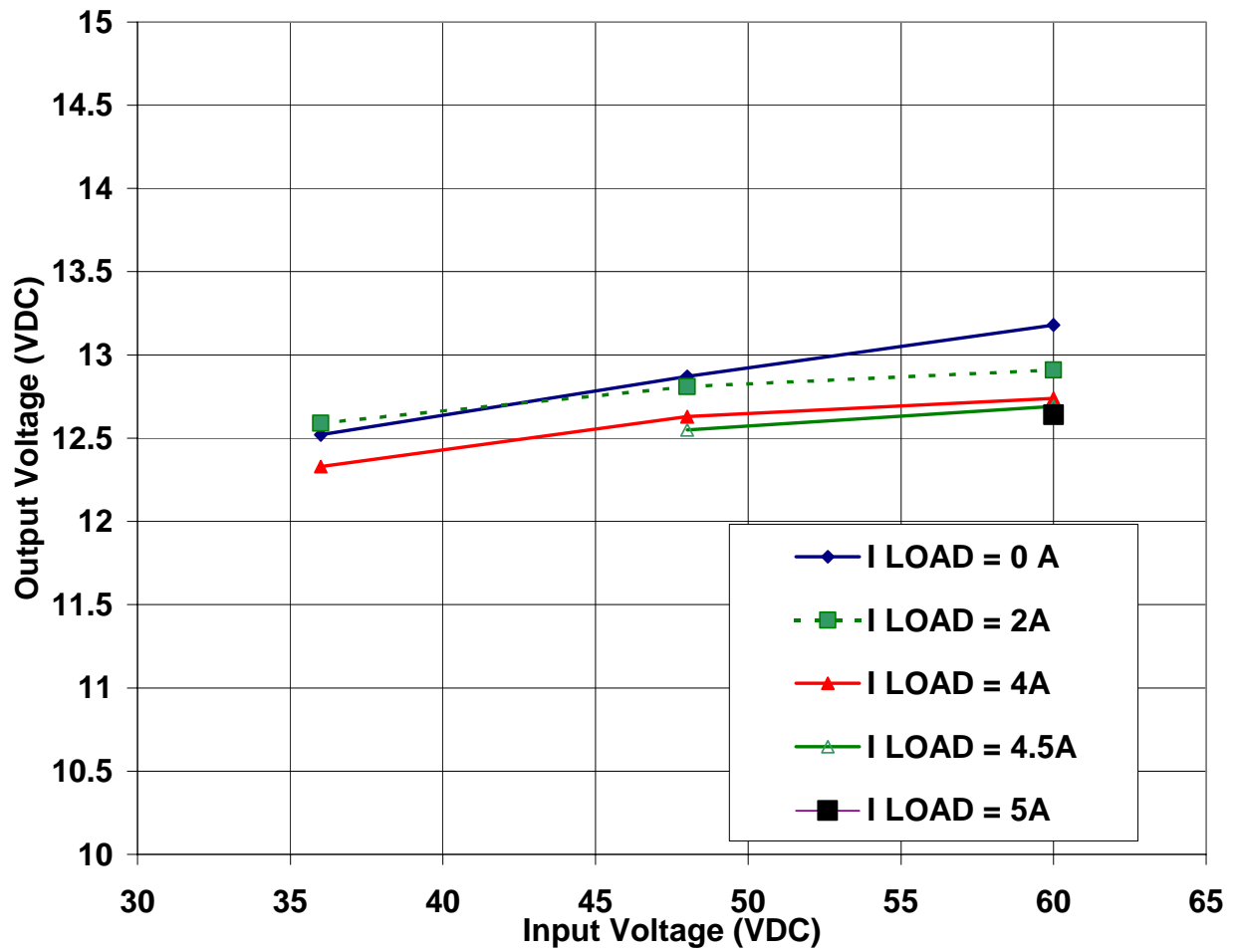

Figure 7 - Line Regulation, Room Temperature



10 Waveforms

10.1 Drain Voltage, Normal Operation

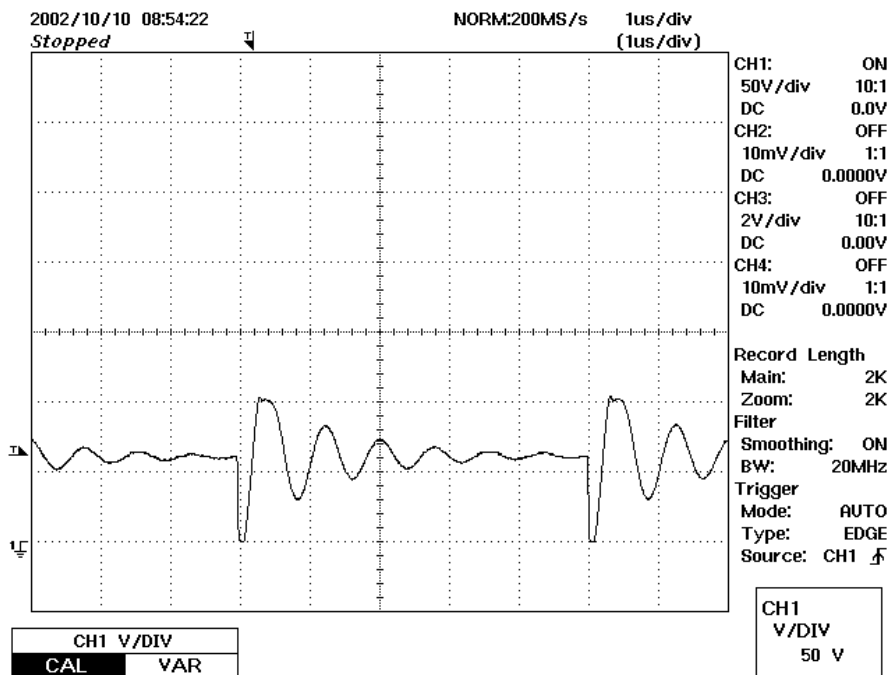

Figure 8 - 60VDC No Load- VDS, 20V / div

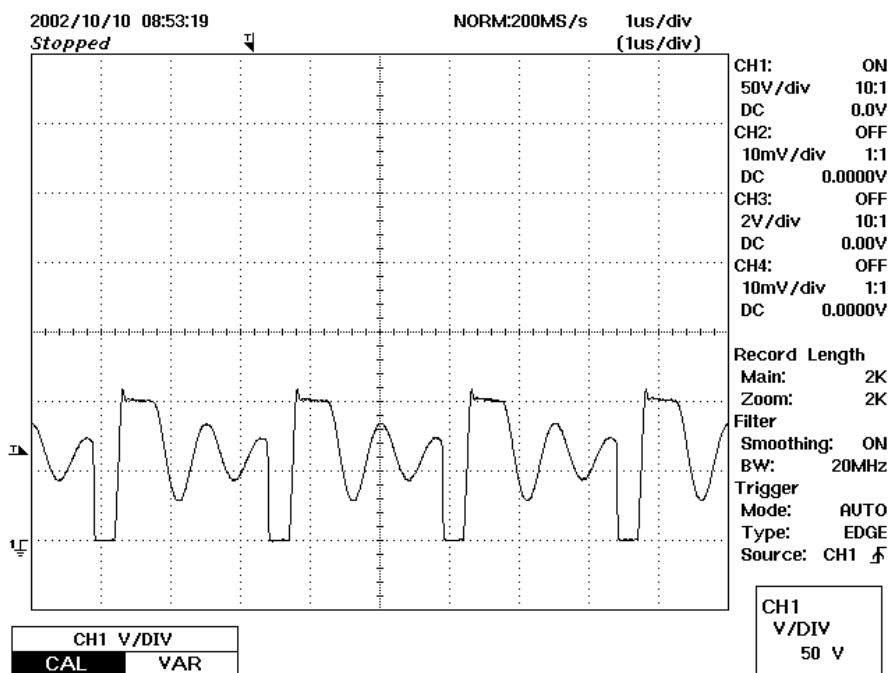

Figure 9 - 60VDC I = 5A - VDS 20V / div



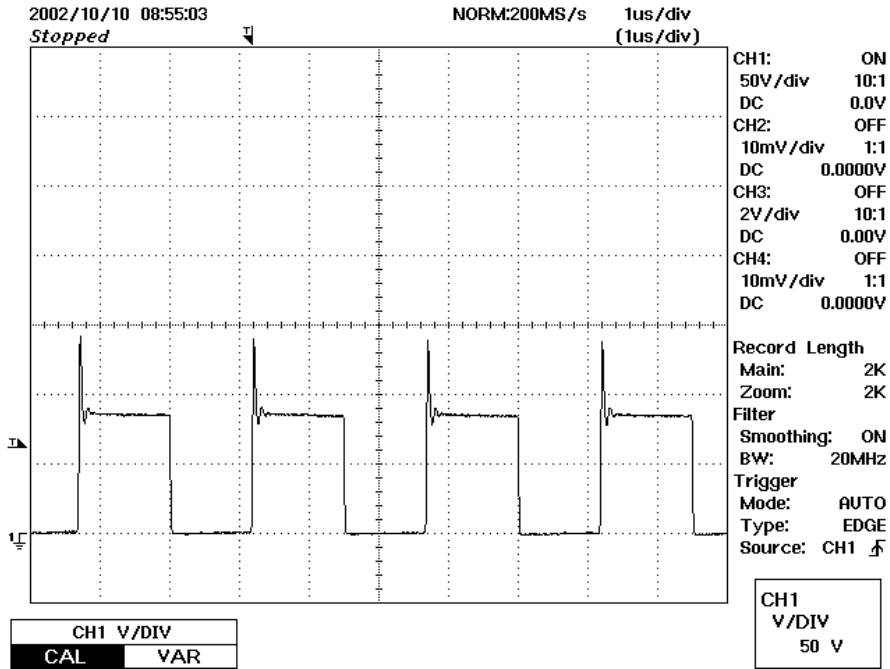

Figure 10 - 48VDC I = 2.5A - VDS, 50V / div

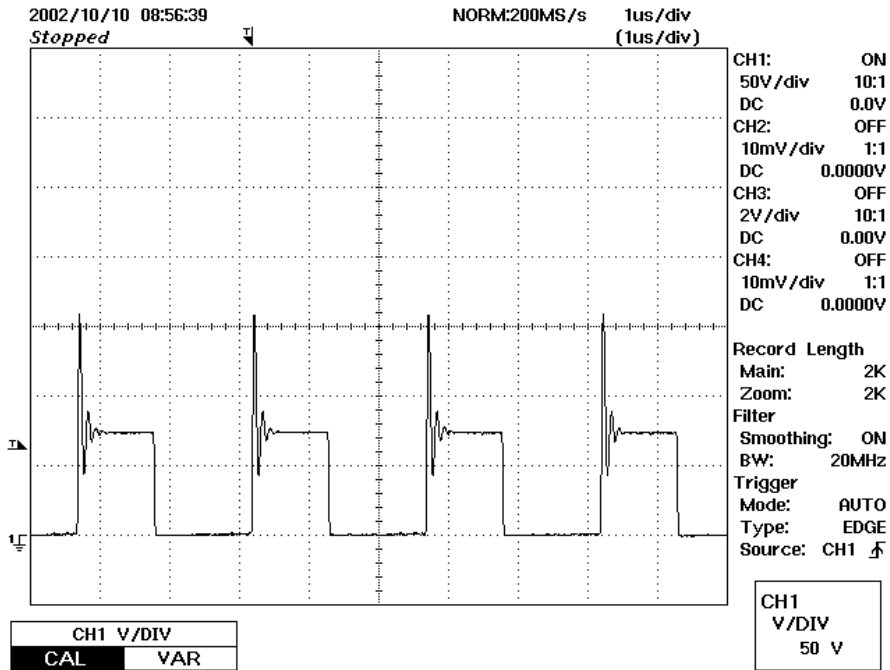

Figure 11 - 36VDC I = 4A - VDS, 50V / div



10.2 Output Voltage Start-up Profile

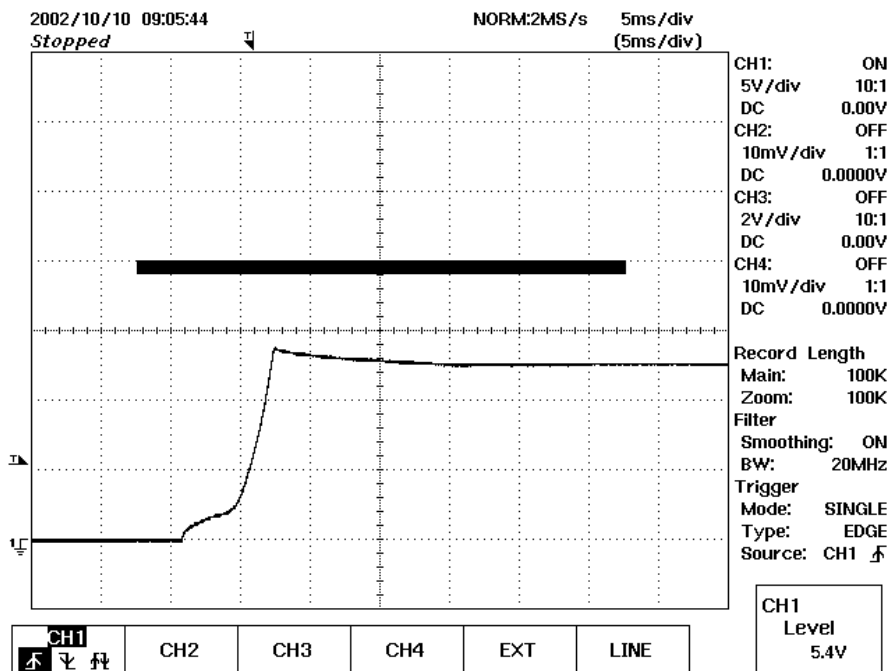

Figure 12 - Start-up Profile, $V_{in} = 48V$, No Load (5msec/div) & (5V/div)

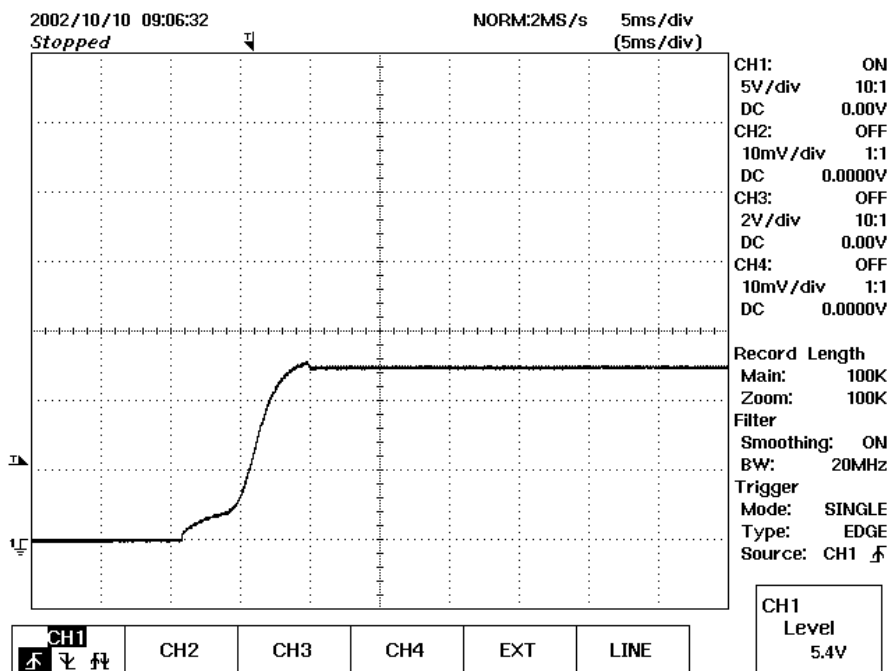

Figure 13 - Start-up Profile, $V_{in} = 48V$, $I = 4.5A$ (5msec/div) & (1V/div)



10.3 Output Ripple Measurements

10.3.1 Ripple Measurement Technique

For DC output ripple measurements, a modified oscilloscope test probe must be utilized in order to reduce spurious signals due to pickup. Details of the probe modification are provided in Figure 14 and Figure 15.

The 5125BA probe adapter is affixed with two capacitors tied in parallel across the probe tip. The capacitors include one (1) 0.1 $\mu\text{F}/50\text{ V}$ ceramic type and one (1) 1.0 $\mu\text{F}/50\text{ V}$ aluminum electrolytic. **The aluminum electrolytic type capacitor is polarized, so proper polarity across DC outputs must be maintained (see below).**

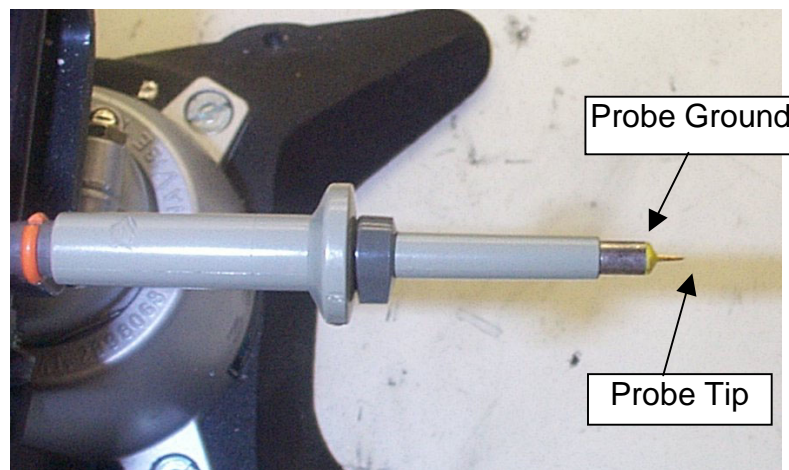

Figure 14 - Oscilloscope Probe Prepared for Ripple Measurement. (End Cap and Ground Lead Removed)

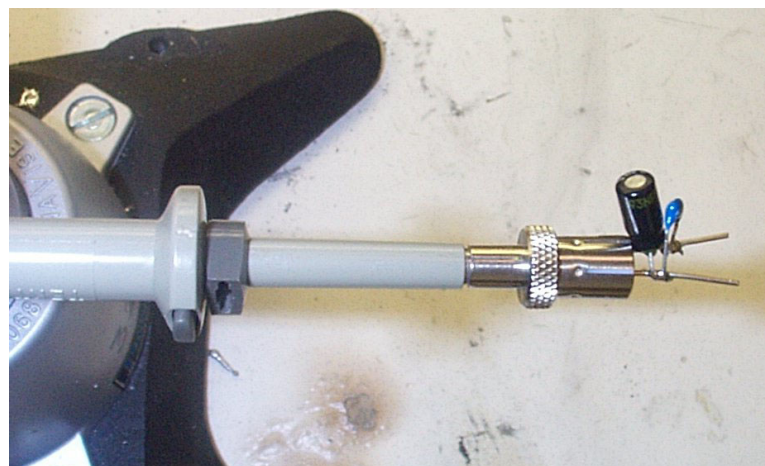

Figure 15 - Oscilloscope Probe with Probe Master 5125BA BNC Adapter. (Modified with wires for probe ground for ripple measurement, and two parallel decoupling capacitors added)

10.3.2 Measurement Results

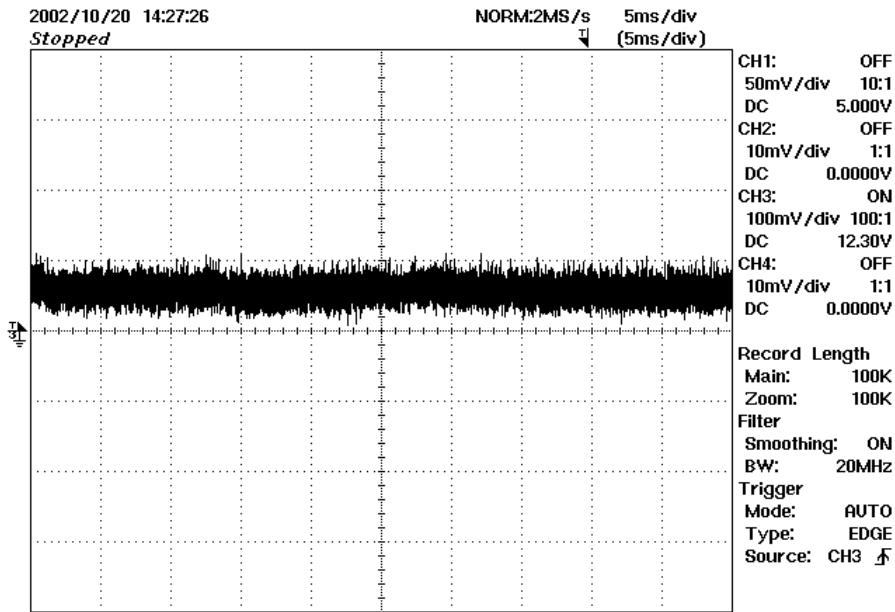

Figure 16 - Vin = 36VDC, I = 4A (5 ms, 50 mV / div)

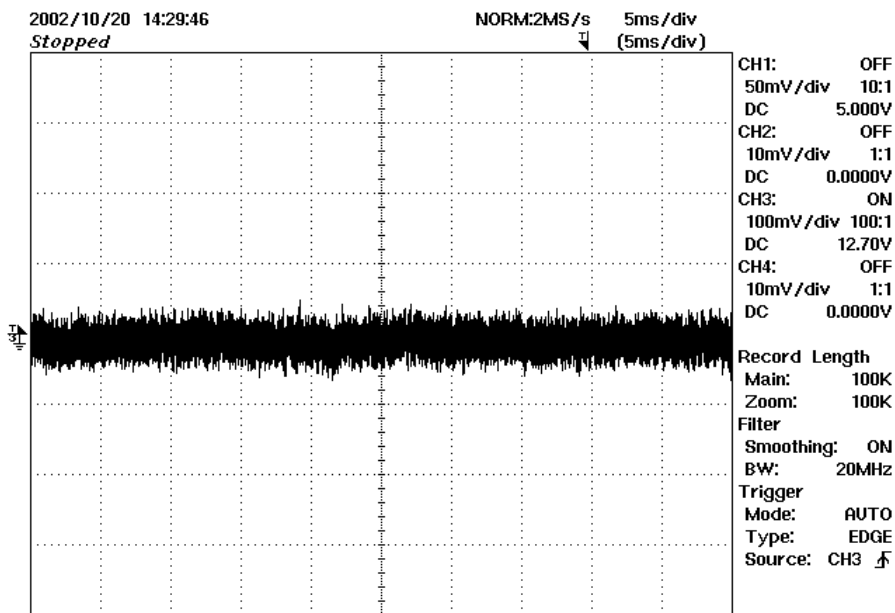

Figure 17 - Vin = 60VDC, I = 5A (5 ms, 50 mV / div)



11 Revision History

Date	Author	Revision	Description & changes	Reviewed
March 30, 2004	RSP	1.0	Initial release	VC / AM



Notes



For the latest updates, visit our Web site: www.powerint.com

Power Integrations reserves the right to make changes to its products at any time to improve reliability or manufacturability. Power Integrations does not assume any liability arising from the use of any device or circuit described herein, nor does it convey any license under its patent rights or the rights of others.

The products and applications illustrated herein (including circuits external to the products and transformer construction) may be covered by one or more U.S. and foreign patents or potentially by pending U.S. and foreign patent applications assigned to Power Integrations. A complete list of Power Integrations' patents may be found at www.powerint.com.

The PI Logo, **TOPSwitch**, **TinySwitch**, **LinkSwitch**, and **EcoSmart** are registered trademarks of Power Integrations, Inc. **PI Expert** and **DPA-Switch** are trademarks of Power Integrations, Inc.
© Copyright 2003, Power Integrations, Inc.

WORLD HEADQUARTERS AMERICAS

Power Integrations, Inc.
5245 Hellyer Avenue
San Jose, CA 95138 USA.
Main: +1-408-414-9200
Customer Service:
Phone: +1-408-414-9665
Fax: +1-408-414-9765
E-Mail:
usasales@powerint.com

CHINA

Power Integrations
International Holdings, Inc.
Rm# 1705, Bao Hua Bldg.
1016 Hua Qiang Bei Lu
Shenzhen Guangdong,
518031, China
Phone: +86-755-8367-5143
Fax: +86-755-8377-9610
E-Mail:
chinasales@powerint.com

APPLICATIONS HOTLINE

World Wide +1-408-414-9660

EUROPE & AFRICA

Power Integrations (Europe) Ltd.
Centennial Court
Easthampstead Road
Bracknell
Berkshire RG12 1YQ,
United Kingdom
Phone: +44-1344-462-300
Fax: +44-1344-311-732
E-Mail:
eurosales@powerint.com

KOREA

Power Integrations
International Holdings, Inc.
Rm# 402, Handuk Building,
649-4 Yeoksam-Dong, Kangnam-
Gu
Seoul, Korea
Phone: +82-2-568-7520
Fax: +82-2-568-7474
E-Mail:
koreasales@powerint.com

APPLICATIONS FAX

World Wide +1-408-414-9760

SINGAPORE

Power Integrations, Singapore
51 Goldhill Plaza #16-05
Republic of Singapore 308900
Phone: +65-6358-2160
Fax: +65-6358-2015
E-Mail:
singapore-sales@powerint.com

JAPAN

Power Integrations, K.K.
Keihin-Tatemono 1st Bldg.
12-20 Shin-Yokohama
2-Chome,
Kohoku-ku, Yokohama-shi,
Kanagawa 222-0033, Japan
Phone: +81-45-471-1021
Fax: +81-45-471-3717
E-Mail:
japansales@powerint.com

TAIWAN

Power Integrations
International Holdings, Inc.
17F-3, No. 510,
Chung Hsiao E. Rd., Sec. 5,
Taipei, Taiwan 110, R.O.C.
Phone: +886-2-2727-1221
Fax: +886-2-2727-1223
E-Mail:
taiwansales@powerint.com

INDIA (Technical Support)

Innovatech
#1, 8th Main Road
Vasanthnagar
Bangalore, India 560052
Phone: +91-80-226-6023
Fax: +91-80-228-9727
E-Mail:
indiasales@powerint.com

