



## Design Example Report

<b>Title</b>	<b><i>High Efficiency (<math>\geq 75\%</math>), 3.6 W Isolated LED Driver Using LinkSwitch™-II LNK605DG</i></b>
<b>Specification</b>	90 VAC – 265 VAC Input; 12 V, 0.3 A Output
<b>Application</b>	LED Driver for GU10 Lamp
<b>Author</b>	Applications Engineering Department
<b>Document Number</b>	DER-261
<b>Date</b>	September 24, 2010
<b>Revision</b>	1.5

### Summary and Features

- Low cost, low component count and small printed circuit board footprint solution
  - Frequency jitter for smaller, lower cost EMI filter components
  - Primary side control eliminates secondary side control and optocoupler and provides +/-5% CV and +/-10% CC accuracy
- Integrated protection and reliability features
  - Output open circuit / output short-circuit protected with auto-recovery
  - Over-temperature protection – tight tolerance (+/-5%) with hysteretic recovery for safe PCB temperature under all conditions
  - Extended package pin creepage distance for reliable operation in humid environments - >3.2mm at package
- Designed to meet
  - EN55015B conducted EMI with >10 dB $\mu$ V margin
  - IEC61000-4-5 Class 3 AC line surge
  - IEC61000-4-2 ESD at 4 kV contact / 8 kV air.
  - Ultra-low AC leakage current: <5  $\mu$ A at 265 VAC input (no Y capacitor required)
- EcoSmart™
  - No-load consumption: <50 mW at 265 VAC
  - Efficiency:  $\geq 75\%$  at both 115 VAC and 230 VAC

---

#### Power Integrations

5245 Hellyer Avenue, San Jose, CA 95138 USA.

Tel: +1 408 414 9200 Fax: +1 408 414 9201

[www.powerint.com](http://www.powerint.com)

**PATENT INFORMATION**

The products and applications illustrated herein (including transformer construction and circuits external to the products) may be covered by one or more U.S. and foreign patents, or potentially by pending U.S. and foreign patent applications assigned to Power Integrations. A complete list of Power Integrations' patents may be found at [www.powerint.com](http://www.powerint.com). Power Integrations grants its customers a license under certain patent rights as set forth at <http://www.powerint.com/ip.htm>.



## Table of Contents

1	Introduction .....	5
2	Power Supply Specification .....	7
3	Schematic .....	8
4	Circuit Description .....	9
4.1	Input Filtering .....	9
4.2	LinkSwitch-II Primary .....	9
4.3	Output Rectification .....	9
5	PCB Layout .....	10
6	Bill of Materials .....	11
7	Transformer Specification .....	12
7.1	Electrical Diagram .....	12
7.2	Electrical Specifications .....	12
7.3	Materials .....	12
7.4	Transformer Build Diagram .....	13
7.5	Transformer Construction .....	13
7.6	Step and Procedure for Wrapping Insulation Tape on Transformer .....	14
7.7	Preparation of Assembly Details .....	15
7.8	Assembly of Transformer to PCB .....	16
8	Transformer Design Spreadsheet .....	17
9	Performance Data .....	20
9.1	Efficiency vs. Line and Output Voltage .....	20
9.2	No-Load Power Consumption .....	21
9.3	Output Characteristic .....	22
10	Thermal Performance .....	24
10.1	Measurement with Infrared Camera (Open Frame) .....	24
10.1.1	$V_{IN} = 115 \text{ VAC}$ .....	24
10.1.2	$V_{IN} = 230 \text{ VAC}$ .....	24
10.2	Measurement with Thermocouples (Inside Enclosure) .....	25
11	Waveforms .....	26
11.1	Drain Voltage and Current .....	26
11.2	Drain Voltage and Current Start-up Profile .....	26
12	Line Surge .....	27
13	Hipot Test .....	28
14	ESD Test .....	28
15	Conducted EMI .....	29
16	Revision History .....	33



**Important Note:** Although this board is designed to satisfy safety isolation requirements, the engineering prototype has not been agency approved. Therefore, all testing should be performed using an isolation transformer to provide the AC input to the prototype board.



## 1 Introduction

The document describes a high efficiency LED driver designed to drive 12 V at 0.3 A from an input voltage range of 90 VAC to 265 VAC. The LED driver uses the LNK605DG from the LinkSwitch-II family by Power Integrations.

LinkSwitch-II ICs allow the implementation of cost effective and low component count LED drivers meeting the compact design and high efficiency requirements necessary for high temperature operating environments.

The topology used is an isolated flyback operating in discontinuous conduction mode. Output current regulation is sensed entirely from the primary side eliminating the need for secondary side feedback components. No external current sensing is required on the primary side either as this is performed inside the IC further reducing components and losses.

The LNK605DG also provides a sophisticated range of protection features including auto-restart for open control loop and output short-circuit conditions. Accurate hysteretic thermal shutdown ensures safe average PCB temperatures under all conditions.

In LED luminaires the driver determines many of the performance attributes experienced by the end user including startup time and unit to unit consistency. For this design, the LNK605DG device ensures unit to unit consistency with an output CC tolerance of  $<\pm 10\%$ , fast startup time of  $<5$  ms for instant on performance and long lifetime and high reliability due to the low component count.

This document contains the LED driver specification, schematic, PCB diagram, bill of materials, transformer documentation and typical performance characteristics.



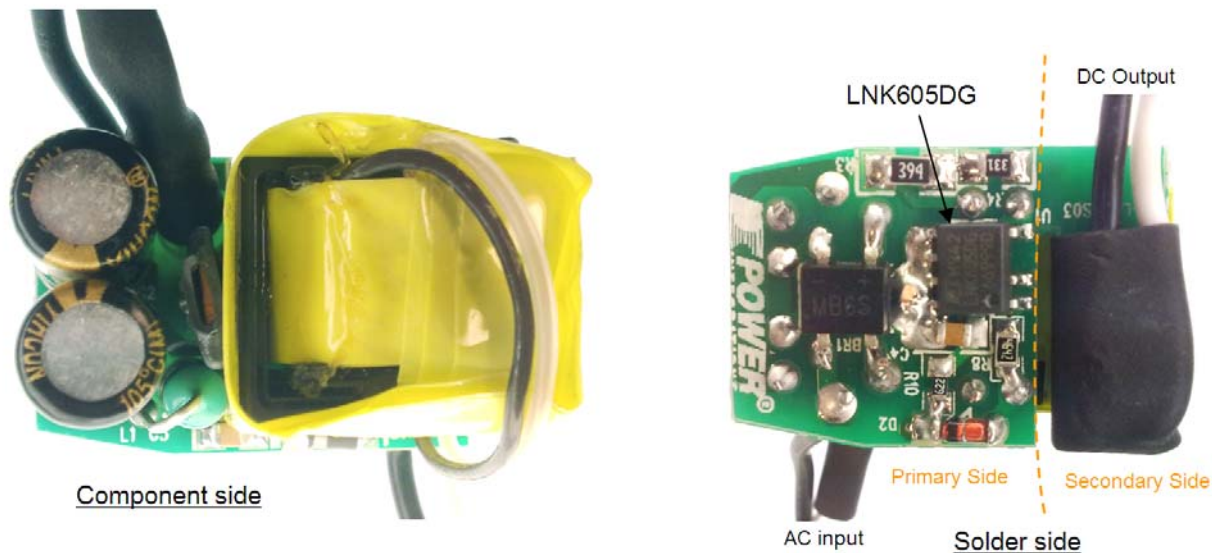


Figure 1 – Populated Circuit Board Photograph.



The size of the driver is design to be fitted into a 2 screws holes GU10 lamp housing



Figure 2 – Assembled Driver Inside GU10 Base.



## 2 Power Supply Specification

The table below represents the minimum acceptable performance of the design. Actual performance is listed in the results section.

Description	Symbol	Min	Typ	Max	Units	Comment
<b>Input</b>						
Voltage	$V_{IN}$	90	115/230	265	VAC	2 Wire – no P.E.
Frequency	$f_{LINE}$	47	50/60	64	Hz	
<b>Output</b>						
Output Voltage	$V_{OUT}$	10.5	11	12.1	V	$V_{OUT} = 12, V_{IN} = 230 / 115 \text{ VAC}, 25^{\circ}\text{C}$
Output Current	$I_{OUT}$		0.3		A	
<b>Total Output Power</b>						
Continuous Output Power	$P_{OUT}$		3.6		W	
<b>Efficiency</b>						
Full Load	$\eta$	75			%	Measured at $P_{OUT} 25^{\circ}\text{C}$ and input 115 / 230 VAC
<b>Environmental</b>						
Conducted EMI		Meets CISPR 15B / EN55015B				
Safety		Designed to meet IEC950 / UL1950 Class II				
ESD		4 8			kV kV	Contact Discharge Air Discharge
Ring Wave (100 kHz) Differential Mode (L1-L2)			2		kV	EN 61000-4-5 , 200 A
Ambient Temperature	$T_{AMB}$		70		$^{\circ}\text{C}$	Free convection, sea level

### Notes:

- Ambient temperature is specified with a small heatsink added on the PCB next to LinkSwitch-II device.



### 3 Schematic

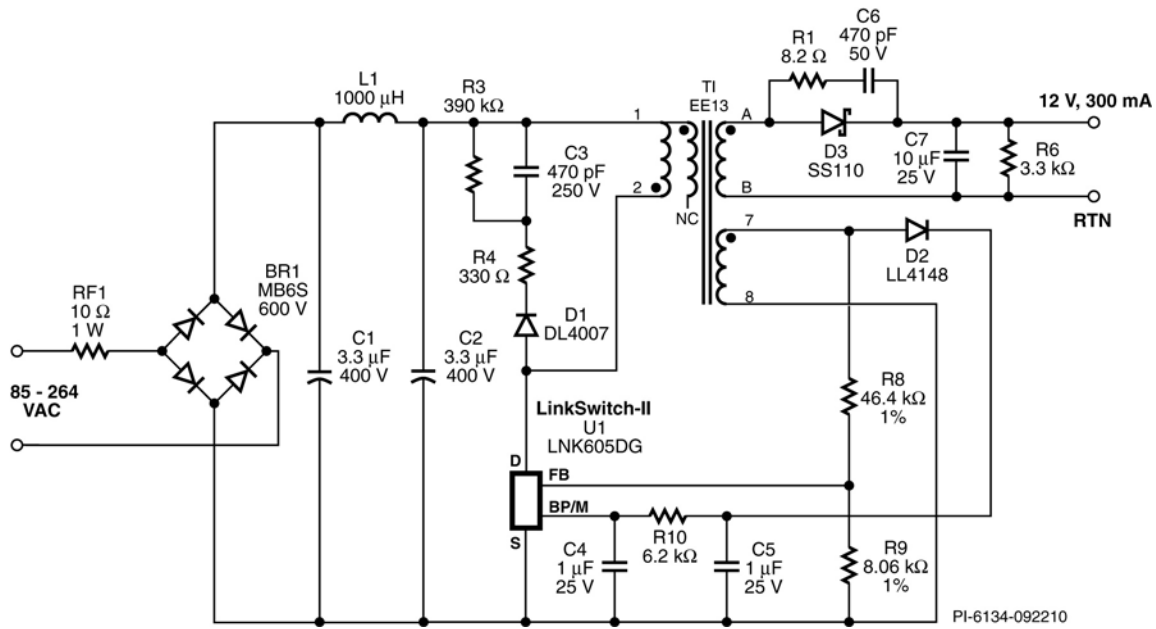


Figure 3 – Schematic.



## 4 Circuit Description

The LinkSwitch-II device is an integrated controller plus 700 V power MOSFET intended for use in LED driver or charger applications. The LinkSwitch-II is configured for use in a single-stage discontinuous conduction mode flyback topology and provides a primary side regulated constant voltage and current output.

### 4.1 Input Filtering

AC input power is rectified by bridge rectifier BR1. The rectified DC is filtered by the bulk storage capacitors C1 and C2. Inductors L1, C1 and C2 form a pi ( $\pi$ ) filter, which attenuates conducted differential-mode EMI noise. This configuration along with Power Integrations transformer E-shield™ technology allow this design to meet EMI standard EN55015 Class B with good margin without requiring a Y capacitor. The transformer construction also gives very good EMI repeatability. Fusible resistor RF1 provides protection against catastrophic failure. This should be a wire wound type to withstand the instantaneous dissipation when first connected to AC while the input capacitors charge.

### 4.2 LinkSwitch-II Primary

The LNK605DG device (U1) incorporates the power switching device, oscillator, CC/CV control engine, startup, and protection functions. The integrated 700 V power MOSFET allows for sufficient voltage margin in universal input AC applications. The device is powered from the BYPASS pin via the decoupling capacitor C4 during startup.

The rectified and filtered input voltage is applied to one end of the primary winding of T1. The other side of the transformer's primary winding is driven by the integrated 700 V power MOSFET in U1. The leakage inductance drain voltage spike is limited by an RCD-R clamp consisting of D1, R3, R4, and C3.

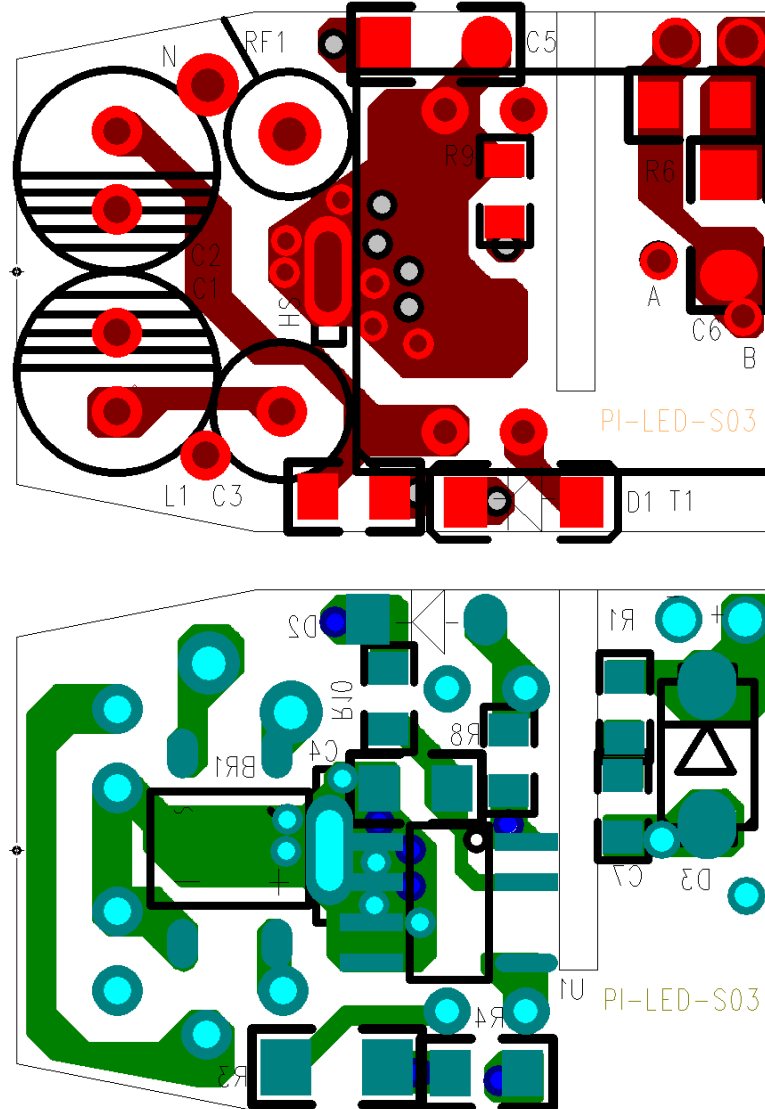
Diode D2, C5 and R10 create the primary bias supply. This voltage created from the transformer bias winding supplies bias current into the BYPASS pin through D2 and R10. The LNK605DG can be configured with or without an optional bias supply. When configured to be supplied from a bias supply (as in this design), the no-load power consumption reduces to <50 mW.

### 4.3 Output Rectification

The secondary of the transformer is rectified by D3; a Schottky barrier type was selected for higher efficiency, and filtered by C7. For this application a ceramic capacitor was selected for C7 to provide longer life time compared to an electrolytic type due to the high operating ambient temperature. Resistor R1 and C6 dampen high frequency ringing and reduce the diode voltage stress.



### 5 PCB Layout



**Figure 4** – Printed Circuit Layout (Designed to Fit Inside GU10 Lamp Form Factor).  
24.31 mm (L) x 16.50 mm x 13.50 mm.



## 6 Bill of Materials

Item	Qty.	Ref Des	Description	Mfg Part Number	Manufacturer
1	1	BR1	600 V, 0.5 A, Bridge Rectifier, SMD, MBS-1, 4-SOIC	MB6S	Micro Commercial
2	1	C1 C2	3.3 $\mu$ F, 400 V, Electrolytic, (6.3 x 12)	TM1332PE12MCP	YIH HONG MAO Electronics Co.
3	1	C3	470 pF, 250 V, Ceramic, X7R, 0805	ECJ-2VB2A471K	Panasonic
4	2	C4 C5	1 $\mu$ F, 25 V, Ceramic, X7R, 0805	ECJ-2FB1E105K	Panasonic
5	1	C6	470 pF 50 V, Ceramic, X7R, 0603	ECJ-1VC1H471J	Panasonic
6	1	C7	10 $\mu$ F, 25 V, Ceramic, X7R, 1206	ECJ-3YB1E106M	Panasonic
7	1	D1	1000 V, 1 A, Rectifier, Glass Passivated, DO-213AA (MELF)	DL4007-13-F	Diodes Inc
8	1	D2	75 V, 0.15 A, Fast Switching, 4 ns, MELF	LL4148-13	Diode Inc.
9	1	D3	100 V, 1 A, Schottky, DO-214AC (SMA)	SS110	Micro commercial.
10	1	L1	1000 $\mu$ H, 0.08 A, Ferrite Core, Shielded	1641-105K	API Delevan
11	1	R1	8.2 $\Omega$ , 5%, 1/10 W, Thick Film, 0603	ERJ-3GEYJ8R2V	Panasonic
12	1	R3	390 k $\Omega$ , 5%, 1/4 W, Thick Film, 1206	ERJ-8GEYJ394V	Panasonic
13	1	R4	330 $\Omega$ , 5%, 1/8 W, Thick Film, 0805	ERJ-6GEYJ331V	Panasonic
14	1	R6	3.3 k $\Omega$ , 5%, 1/10 W, Thick Film, 0603	ERJ-3GEYJ332V	Panasonic
15	1	R8	46.4 k $\Omega$ , 1%, 1/16 W, Thick Film, 0603	ERJ-3EKF4642V	Panasonic
16	1	R9	8.06 k $\Omega$ , 1%, 1/16 W, Thick Film, 0603	ERJ-3EKF8061V	Panasonic
17	1	R10	6.2 k $\Omega$ , 5%, 1/10 W, Thick Film, 0603	ERJ-3GEYJ622V	Panasonic
18	1	RF1	10 $\Omega$ , 1 W, Fusible/Flame Proof Wire Wound	CRF251-4 10R	Vitrohm
19	1	T1	Bobbin, EE13, Vertical, 8 pins	BE13-1110CPSFR	TDK
20	1	U1	LinkSwitch-II, LNK605DG, CV/CC, SO-8C	LNK605DG	Power Integrations



## 7 Transformer Specification

### 7.1 Electrical Diagram

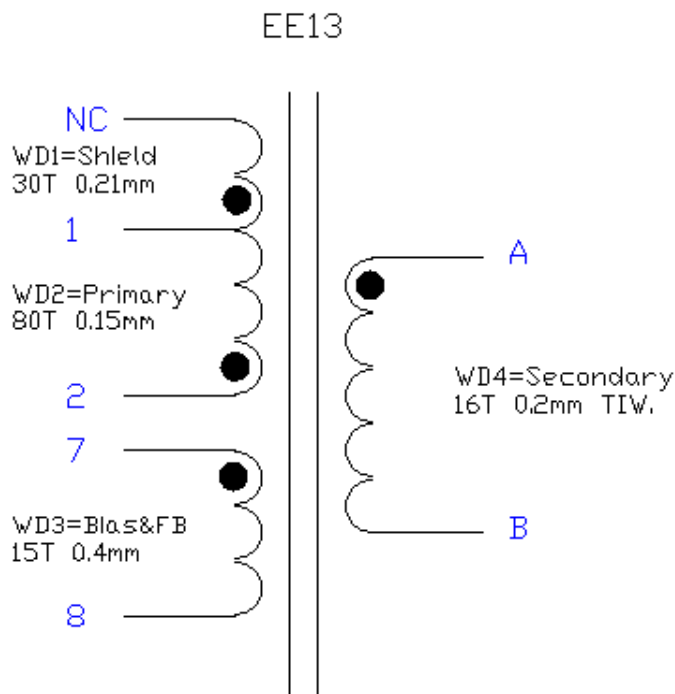


Figure 5 – Transformer Electrical Diagram.

### 7.2 Electrical Specifications

<b>Electrical Strength</b>	1 second, 60 Hz, from pins 1, 2, 7, 8 to A, B	3000 VAC
<b>Primary Inductance</b>	Pins 1 - 2, all other windings open, measured at 100 kHz, 0.4 VRMS	1.10 mH $\pm$ 10%
<b>Resonant Frequency</b>	Pins 1 - 2, all other windings open	750 kHz (Min.)
<b>Primary Leakage Inductance</b>	Pins 1 - 2 with A - B shorted, measured at 100 kHz, 0.4 VRMS	35 $\mu$ H $\pm$ 10%

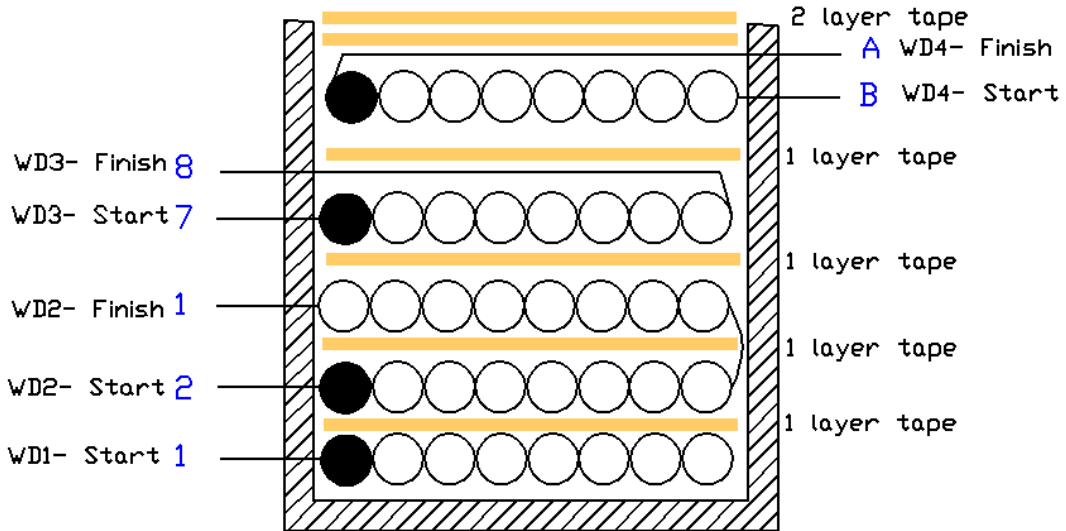
### 7.3 Materials

Item	Description
[1]	Core: PC40 from TDK or equivalent, ALG = 1130.00nH/n <sup>2</sup>
[2]	Bobbin: 8 pin vertical, BE13-1110CPSFR from TDK, or equivalent
[3]	Magnet Wire: 0.21mm Diameter.
[4]	Magnet Wire: 0.15mm Diameter.
[5]	Magnet Wire: 0.4mm Diameter.
[6]	Magnet Wire: 0.2mm Diameter T.I.W.
[7]	Tape: 3M 1298 Polyester Film, 8 mm wide.
[8]	Tape: 3M 1298 Polyester Film, 12 mm wide and 156 mm long.
[9]	Tape: 3M 1298 Polyester Film, 14 mm wide and 182 mm long.
[10]	Varnish.



**7.4 Transformer Build Diagram**

**Pins Side**



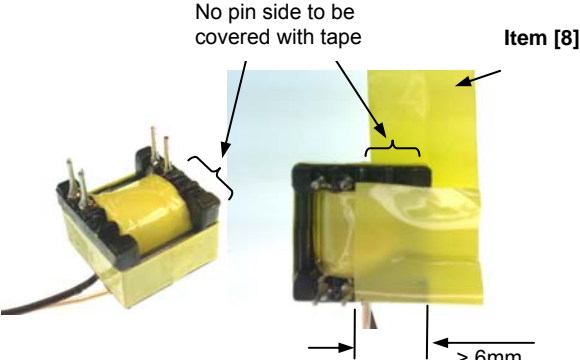
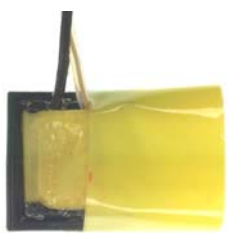
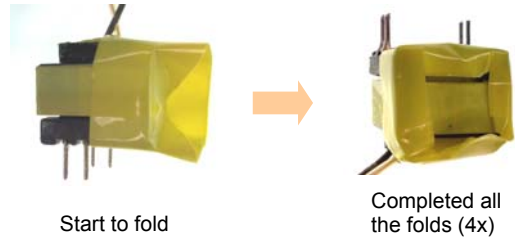
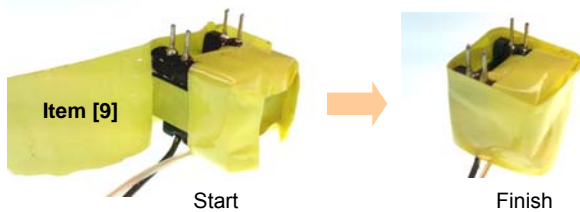
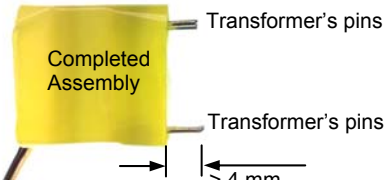
**Figure 6 – Transformer Build Diagram.**

**7.5 Transformer Construction**

<b>Bobbin Preparation</b>	Place the bobbin item [2] on the mandrel such that pin side on the left side. Winding direction is the clockwise direction.
<b>WD 1</b>	Start at pin 1, wind 30 turns of 0.21 mm item [3] from left to right in one layer. Cut the end of the wire to leave it NC (no connection).
<b>Insulation</b>	Apply one layer of tape [7] for insulation.
<b>WD 2</b>	Start at pin 2, wind 40 turns of 0.15 mm item [4] from left to right with tight tension, and apply 1 layers layer of tape [7]. Continue winding 40 turns of item [4] from right to left and finished at pin 1.
<b>Insulation</b>	Apply one layer of tape [7] for insulation.
<b>WD 3</b>	Start at pin 7, wind 15 turns of 0.4 mm [5] wire from left to right. Finish at pin 8.
<b>Insulation</b>	Apply one layer of tape [7] for insulation.
<b>WD 4</b>	Continue to wind with floating wire, 16 turns of 0.2 mm T.I.W wire [6] from left to right. Start marked as A and finish marked as B.
<b>Insulation</b>	Apply two layers of tape [7] for insulation.
<b>Final Assembly</b>	Cut A, B wires length to 0.75". Grind core. Assemble core. Varnish using item [10] and wrap the transformer using item [8], [9]. Refer the 7.6 for transformer insulation wrap.



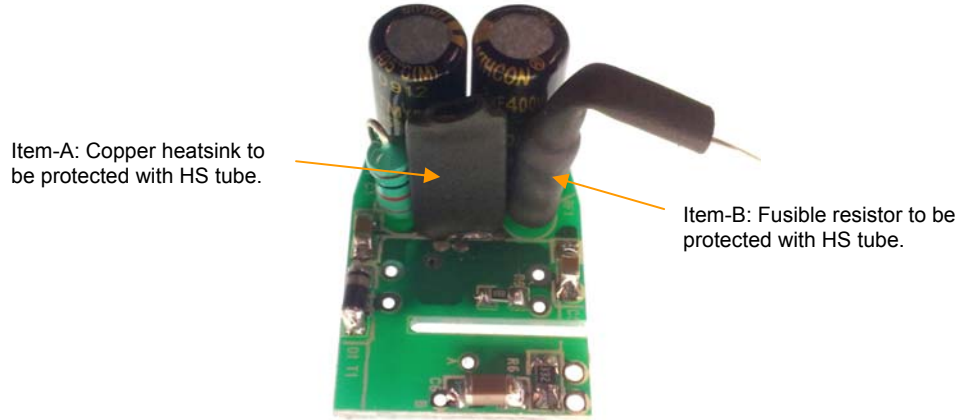
**7.6 Step and Procedure for Wrapping Insulation Tape on Transformer**

<p>Step 1</p>		<p>Transformer to be wrapped with all electrical tests and varnishing completed. The wrapping is started at the no-pin side. Wrap the insulation tape item [8] on to the no pin side area and make sure the tape has extended and covered the core by at least 6mm.</p>
<p>Step 2</p>		<p>Fully wrap the tape around the transformer with minimum 3 turns with item [8]</p>
<p>Step 3</p>		<p>Bend the tape inward and make a complete fold to all the 4 sides.</p>
<p>Step 4</p>		<p>Wrap the insulation tape item [9] on to the core side of the assembly with minimum of 3 turns. Allow the tape to be covered up to the termination.</p>
<p>Step 5</p>		<p>Complete assembly and leave ~4 mm of the lead for soldering.</p>



### 7.7 Preparation of Assembly Details

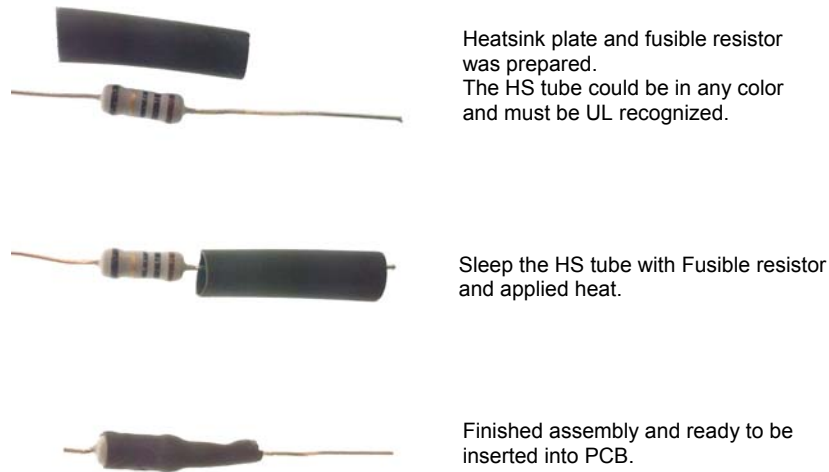
#### Preparation of copper heatsink and fusible resistor



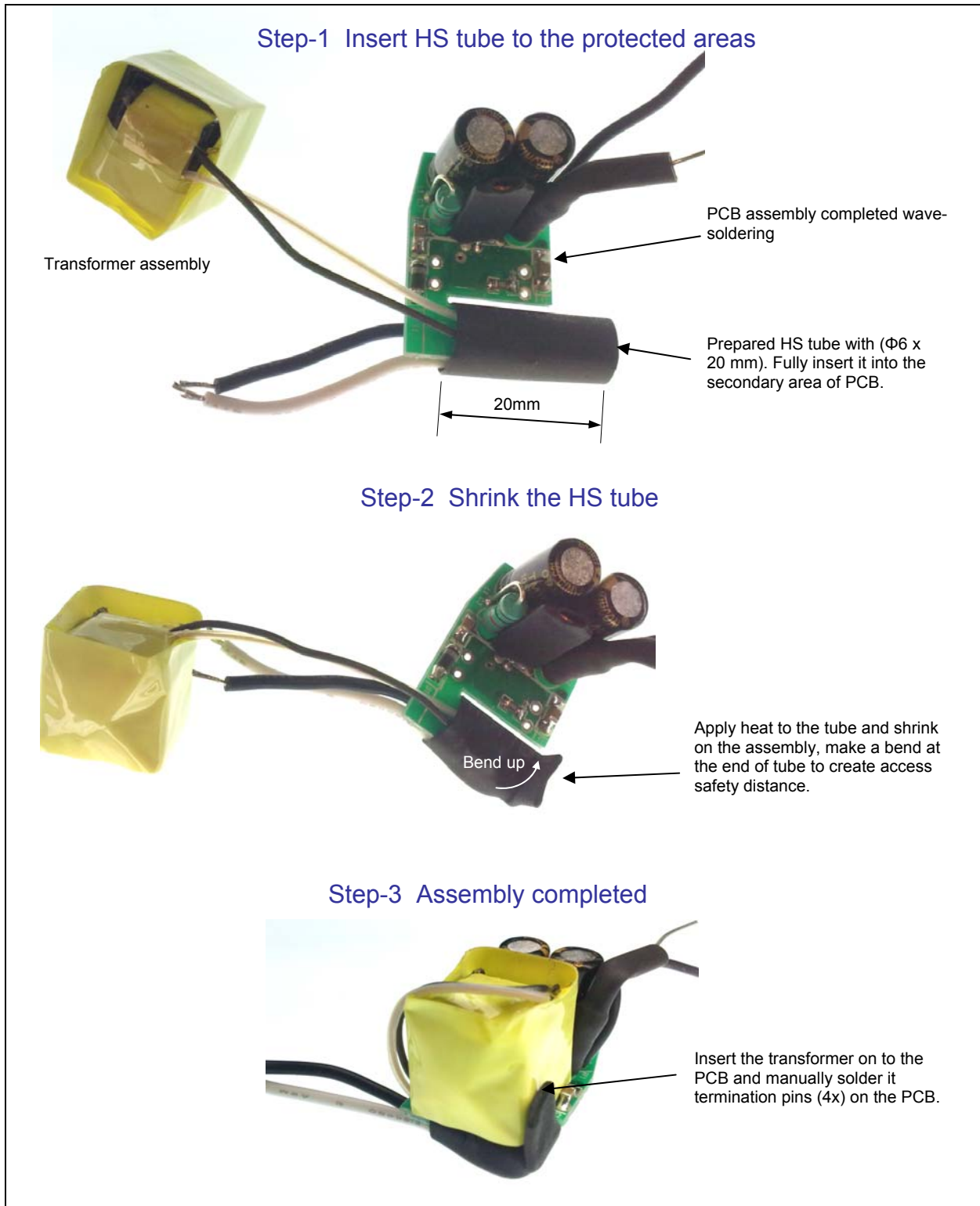
#### Item-A: Protect copper heatsink with heat shrinkable tube



#### Item-B: Protect fusible resistor with heat shrinkable tube



### 7.8 Assembly of Transformer to PCB



## 8 Transformer Design Spreadsheet

ACDC_LinkSwitch-II_120209; Rev.1.11; Copyright Power Integrations 2009	INPUT	INFO	OUTPUT	UNIT	ACDC_LinkSwitch-II_120209_Rev1-11; LinkSwitch-II Discontinuous Flyback Transformer Design Spreadsheet
<b>ENTER APPLICATION VARIABLES</b>					
VACMIN	90			V	Minimum AC Input Voltage
VACMAX	265			V	Maximum AC Input Voltage
fL	50			Hz	AC Mains Frequency
VO	12			V	Output Voltage (at continuous power)
IO	0.3			A	Power Supply Output Current (corresponding to peak power)
Power			3.60	W	Continuous Output Power
n	0.76		0.76		Efficiency Estimate at output terminals. Under 0.7 if no better data available
Z			0.50		Z Factor. Ratio of secondary side losses to the total losses in the power supply. Use 0.5 if no better data available
tC			3.00	ms	Bridge Rectifier Conduction Time Estimate
Add Bias Winding	YES		N/A		!!! Info. Bias winding is not necessary. The feedback winding itself can be used to provide external bias to the LinkSwitch
CIN	6.6			uF	Input Capacitance
<b>ENTER LinkSwitch-II VARIABLES</b>					
Chosen Device	LNK605		LNK605		Chosen LinkSwitch-II device
Package	DG		DG		Select package (PG, GG or DG)
ILIMITMIN			0.30	A	Minimum Current Limit
ILIMITTYP			0.31	A	Typical Current Limit
ILIMITMAX			0.35	A	Maximum Current Limit
FS	80		80.00	kHz	Typical Device Switching Frequency at maximum power
VOR			62.50	V	Reflected Output Voltage (VOR < 135 V Recommended)
VDS			10.00	V	LinkSwitch-II on-state Drain to Source Voltage
VD			0.50	V	Output Winding Diode Forward Voltage Drop
KP			1.88		Ensure KDP > 1.3 for discontinuous mode operation
<b>FEEDBACK WINDING PARAMETERS</b>					
NFB			15.00		Feedback winding turns
VFLY			11.72	V	Flyback Voltage - Voltage on Feedback Winding during switch off time
VFOR			14.71	V	Forward voltage - Voltage on Feedback Winding during switch on time
<b>BIAS WINDING PARAMETERS</b>					
VB			N/A	V	Feedback Winding Voltage (VFLY) is greater than 10 V. The feedback winding itself can be used to provide external bias to the LinkSwitch. Additional Bias winding is not required.



NB			N/A		Bias Winding number of turns
REXT			N/A	k-ohm	Suggested value of BYPASS pin resistor (use standard 5% resistor)
<b>DESIGN PARAMETERS</b>					
DCON	4.6		4.60	us	Output diode conduction time
TON			3.72	us	LinkSwitch-II On-time (calculated at minimum inductance)
RUPPER			47.11	k-ohm	Upper resistor in Feedback resistor divider
RLOWER			8.89	k-ohm	Lower resistor in resistor divider
<b>ENTER TRANSFORMER CORE/CONSTRUCTION VARIABLES</b>					
Core Type					
Core	EE13		EE13		Enter Transformer Core. Based on the output power the recommended core sizes are EE16 or EE19
Bobbin			EE13_BOBBIN		Generic EE13_BOBBIN
AE			17.10	mm <sup>2</sup>	Core Effective Cross Sectional Area
LE			30.20	mm <sup>2</sup>	Core Effective Path Length
AL			1130.00	nH/turn <sup>2</sup>	Ungapped Core Effective Inductance
BW			7.90	mm	Bobbin Physical Winding Width
M			0.00	mm	Safety Margin Width (Half the Primary to Secondary Creepage Distance)
L	2		2.00		Number of Primary Layers
NS			16.00		Number of Secondary Turns. To adjust Secondary number of turns change DCON
<b>DC INPUT VOLTAGE PARAMETERS</b>					
VMIN			78.44	V	Minimum DC bus voltage
VMAX			374.77	V	Maximum DC bus voltage
<b>CURRENT WAVEFORM SHAPE PARAMETERS</b>					
DMAX			0.30		Maximum duty cycle measured at VMIN
Iavg			0.07	A	Input Average current
IP			0.30	A	Peak primary current
IR			0.30	A	Primary ripple current
IRMS			0.11	A	Primary RMS current
<b>TRANSFORMER PRIMARY DESIGN PARAMETERS</b>					
LPMIN			975.96	uH	Minimum Primary Inductance
LPTYP			1084.40	uH	Typical Primary inductance
LP_TOLERANCE			10.00	%	Tolerance in primary inductance
NP			80.00		Primary number of turns. To adjust Primary number of turns change BM_TARGET
ALG			169.44	nH/turn <sup>2</sup>	Gapped Core Effective Inductance
BM_TARGET	2470		2470.00	Gauss	Target Flux Density
BM			2457.33	Gauss	Maximum Operating Flux Density (calculated at nominal inductance), BM < 2500 is recommended
BP		Warning	3021.33	Gauss	!!! Warning. Peak Flux density exceeds 3000 Gauss and is not recommended. Reduce BP by increasing NS
BAC			1228.67	Gauss	AC Flux Density for Core Loss Curves (0.5 X Peak to Peak)



ur			158.81		Relative Permeability of Ungapped Core
LG			0.12	mm	Gap Length (LG > 0.1 mm)
BWE			15.80	mm	Effective Bobbin Width
OD			0.20	mm	Maximum Primary Wire Diameter including insulation
INS			0.04		Estimated Total Insulation Thickness (= 2 * film thickness)
DIA			0.16	mm	Bare conductor diameter
AWG			35.00		Primary Wire Gauge (Rounded to next smaller standard AWG value)
CM			32.00	Cmils	Bare conductor effective area in circular mils
CMA			293.06	Cmils/A	Primary Winding Current Capacity (200 < CMA < 500)
<b>TRANSFORMER SECONDARY DESIGN PARAMETERS</b>					
Lumped parameters					
ISP			1.50	A	Peak Secondary Current
ISRMS			0.61	A	Secondary RMS Current
IRIPPLE			0.53	A	Output Capacitor RMS Ripple Current
CMS			122.33	Cmils	Secondary Bare Conductor minimum circular mils
AWGS			29.00		Secondary Wire Gauge (Rounded up to next larger standard AWG value)
<b>VOLTAGE STRESS PARAMETERS</b>					
VDRAIN			526.02	V	Maximum Drain Voltage Estimate (Assumes 20% clamping voltage tolerance and an additional 10% temperature tolerance)
PIVS			86.95	V	Output Rectifier Maximum Peak Inverse Voltage
<b>FINE TUNING</b>					
RUPPER_ACTUAL			47.11	k-ohm	Actual Value of upper resistor (RUPPER) used on PCB
RLOWER_ACTUAL			8.89	k-ohm	Actual Value of lower resistor (RLOWER) used on PCB
Actual (Measured) Output Voltage (VDC)			12.00	V	Measured Output voltage from first prototype
Actual (Measured) Output Current (ADC)			0.30	Amps	Measured Output current from first prototype
RUPPER_FINE			47.11	k-ohm	New value of Upper resistor (RUPPER) in Feedback resistor divider. Nearest standard value is 47.5 k-ohms
RLOWER_FINE			8.89	k-ohm	New value of Lower resistor (RLOWER) in Feedback resistor divider. Nearest standard value is 8.87 k-ohms

Note: The BP (peak flux density) warning in the spreadsheet was mitigated by verifying the drain current waveforms and confirming that there was no core saturation.



## 9 Performance Data

All measurements performed at room temperature.

### 9.1 Efficiency vs. Line and Output Voltage

Hz	V <sub>IN</sub> (VAC)	P <sub>IN</sub> (W)	V <sub>OUT</sub> (V)	I <sub>OUT</sub> (mA)	P <sub>OUT</sub> (W)	Efficiency (%)
50	90	4.832	12.16	300	3.648	75.5
50	100	4.78	12.16	300	3.648	76.32
50	115	4.736	12.16	300	3.648	77.03
50	130	4.704	12.13	300	3.639	77.36
Hz	V <sub>IN</sub> (VAC)	P <sub>IN</sub> (W)	V <sub>OUT</sub> (V)	I <sub>OUT</sub> (mA)	P <sub>OUT</sub> (W)	Efficiency (%)
50	185	4.752	12.13	300	3.639	76.58
50	200	4.768	12.12	300	3.636	76.26
50	215	4.79	12.1	300	3.63	75.78
50	230	4.826	12.1	300	3.63	75.22
50	245	4.849	12.1	300	3.63	74.86
50	265	4.902	12.1	300	3.63	74.08



## 9.2 No-Load Power Consumption

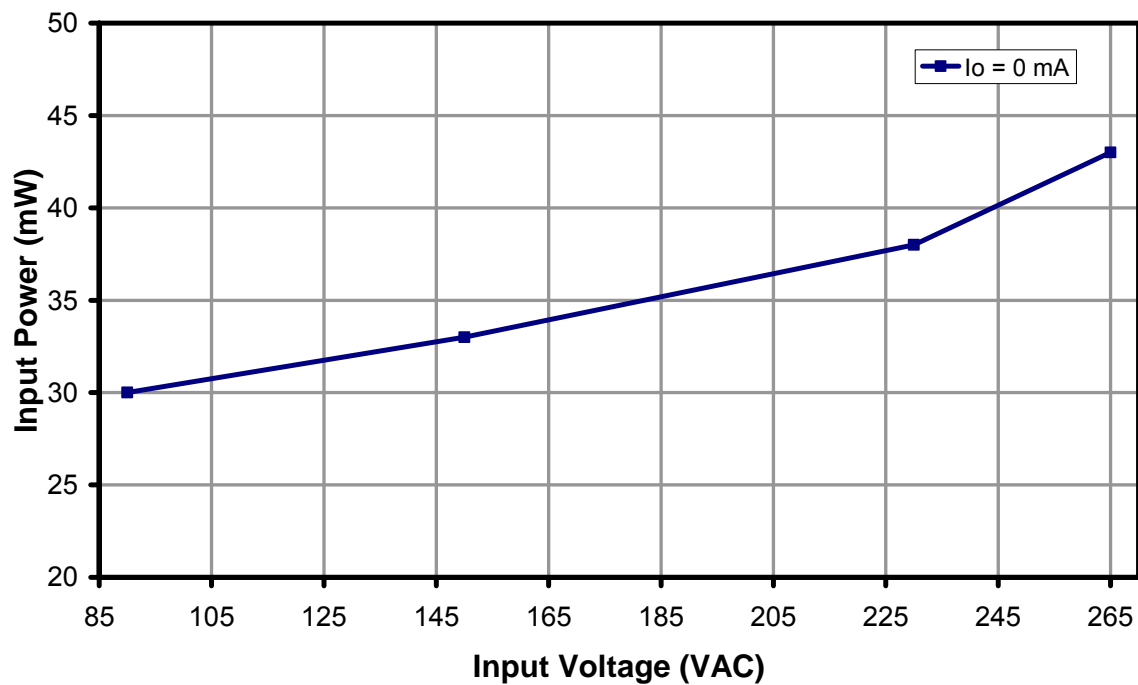


Figure 7 – No-load Power Consumption, Room Temperature.



### 9.3 Output Characteristic

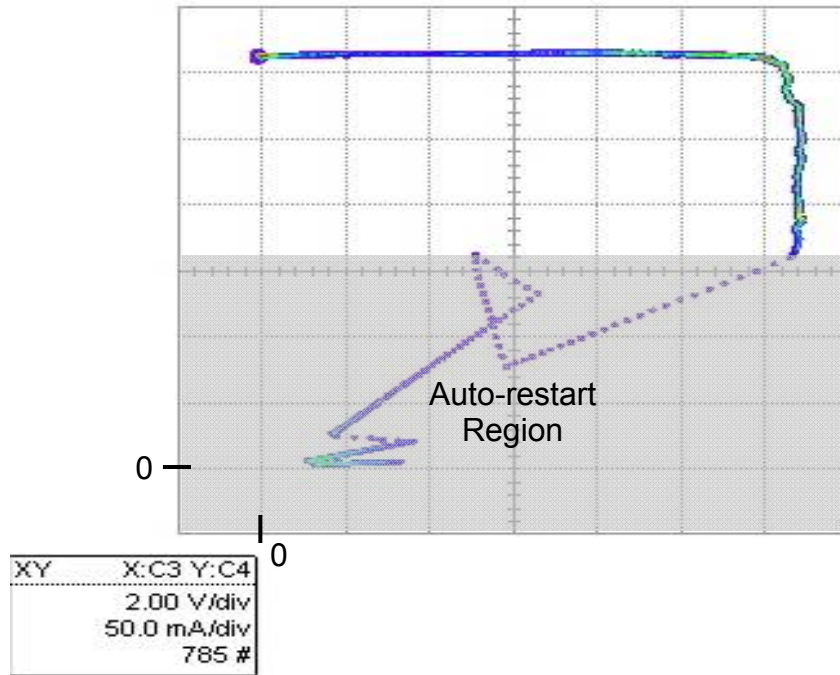


Figure 8 – CC/CV Curve at 90 VAC Input, Room Temperature.

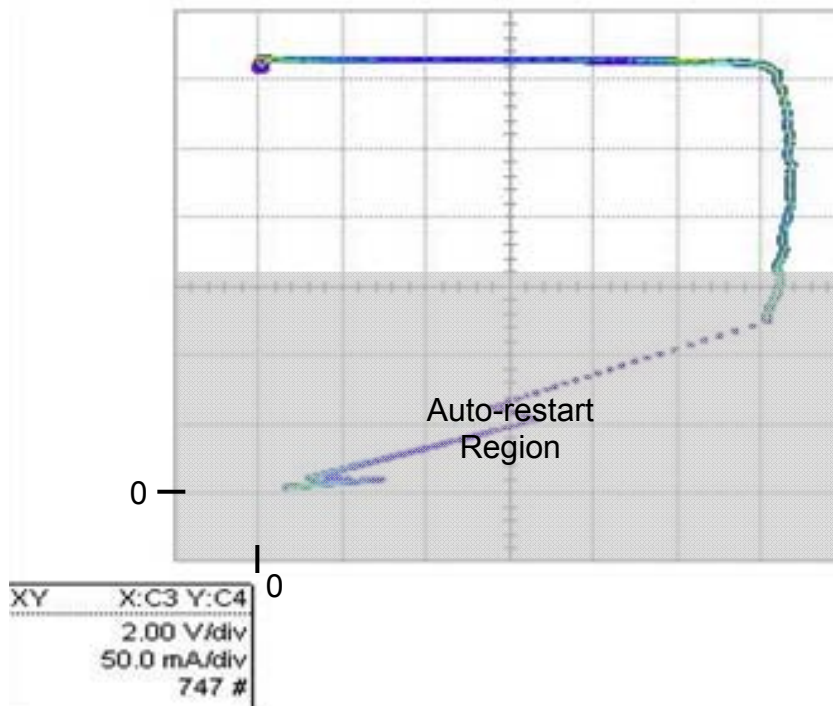


Figure 9 – CC/CV Curve at 120 VAC Input, Room Temperature.



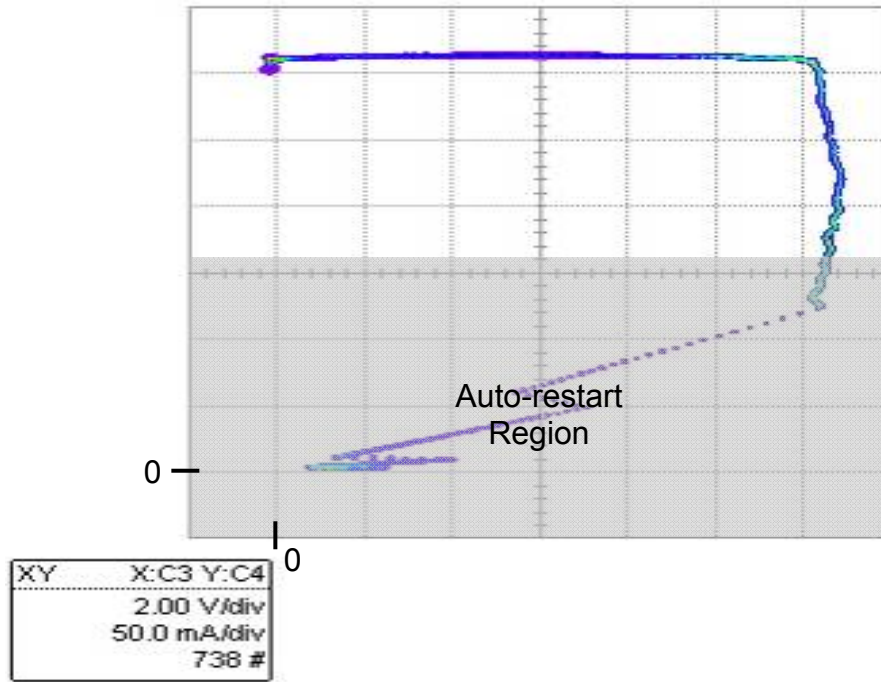


Figure 10 – CC/CV Curve at 230 VAC Input, Room Temperature.

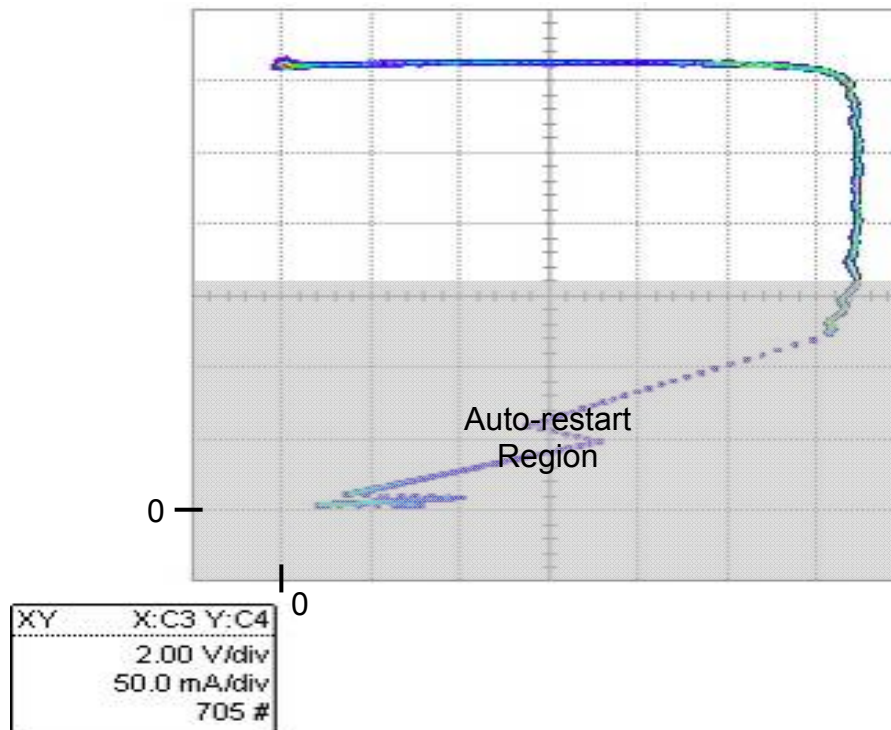


Figure 11 – CC/CV Curve at 265 VAC Input, Room Temperature.



## 10 Thermal Performance

### 10.1 Measurement with Infrared Camera (Open Frame)

Images captured after running 30 minutes at room temp (25°C), full load indicates a LinkSwitch-II device plastic temperature rise of 30°C over ambient. The addition of a small copper heatsink (6 x 12) mm next to the device reduces device operating temperature.

#### 10.1.1 $V_{IN} = 115 \text{ VAC}$

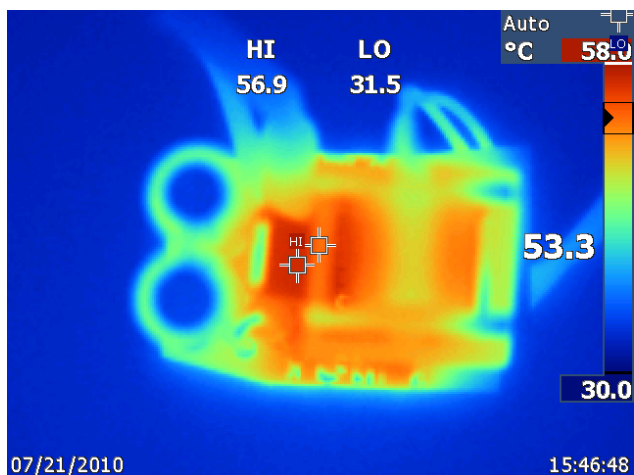


Figure 12 – Top Side.

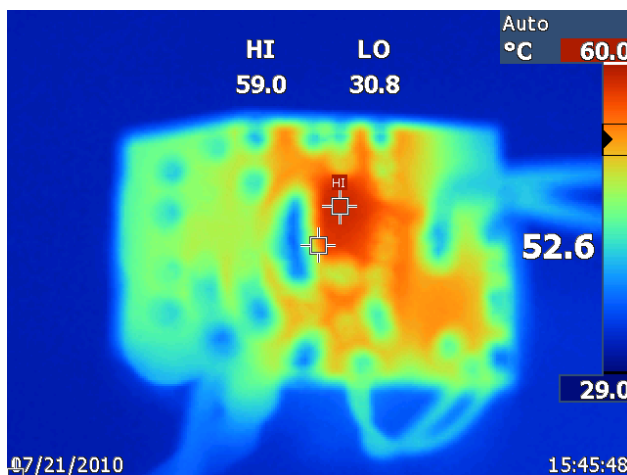


Figure 13 – Bottom Side.

#### 10.1.2 $V_{IN} = 230 \text{ VAC}$

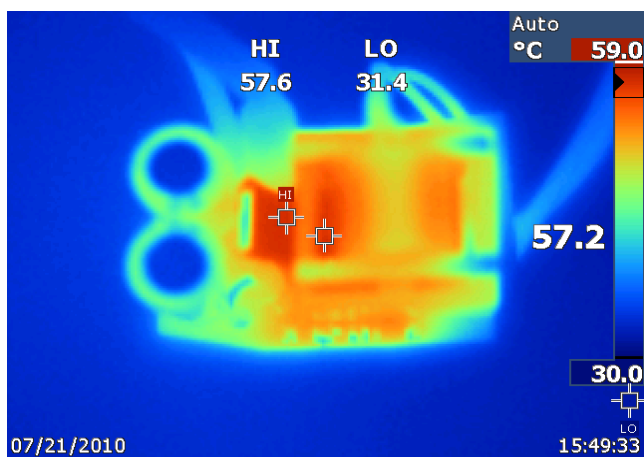


Figure 14 – Top Side.

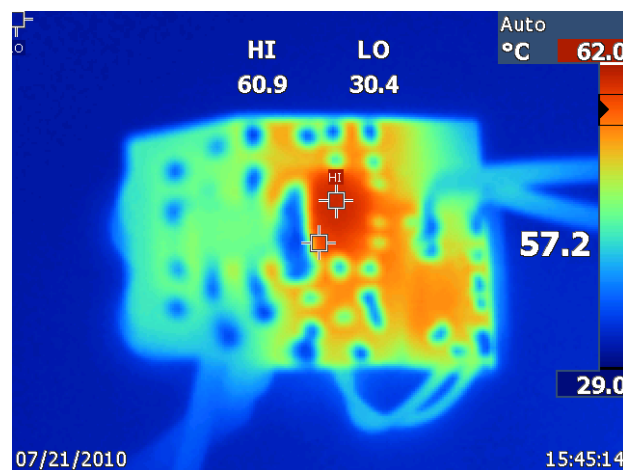


Figure 15 – Bottom Side.

### 10.2 Measurement with Thermocouples (Inside Enclosure)

The completed driver had thermocouples attached to key components when inserted into a GU10 housing. The unit was operated with a case external ambient of 70°C and allowed to reach thermal equivalent before readings were recorded. The measured component temperatures are in the table below.

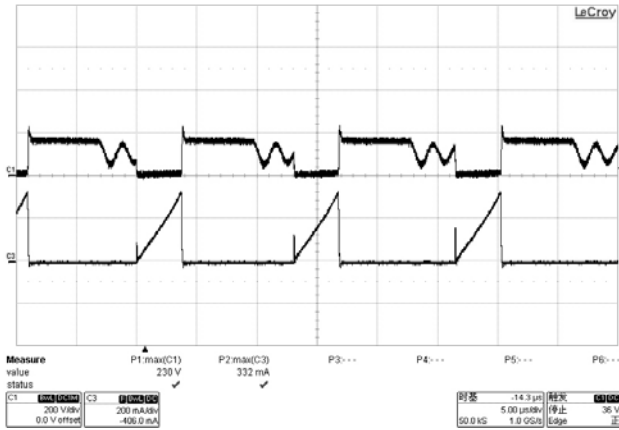
Component Temperature Measurement		
(Under a $T_A$ of 70 °C outside the case external)		
	Input:90 VAC, $T_A=70^\circ\text{C}$	Input:264 VAC, $T_A=70^\circ\text{C}$
U1 (LNK605DG)	112.0	115.0
T1 (winding)	96.1	97.0
T1 (core)	101.1	102.5
D3 (SS110)	94.7	94.9
C1 (3.3 $\mu\text{F}$ / 400 V)	92.9	91.0
C2 (3.3 $\mu\text{F}$ / 400 V)	93.3	91.6



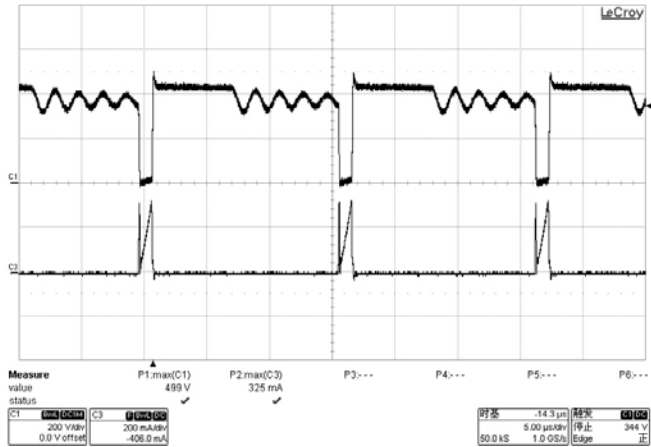
Assembly used for thermal measurement

## 11 Waveforms

### 11.1 Drain Voltage and Current

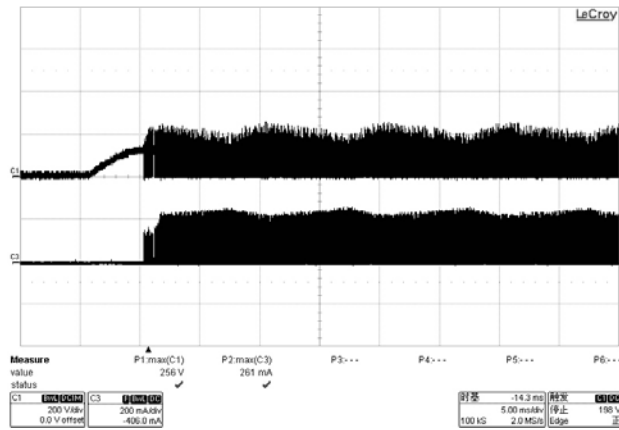


**Figure 16** – 90 VAC, Full Load.  
 Lower:  $I_{DRAIN}$ , 0.2 A / div.  
 Upper:  $V_{DRAIN}$ , 200 V, 5  $\mu$ s / div.

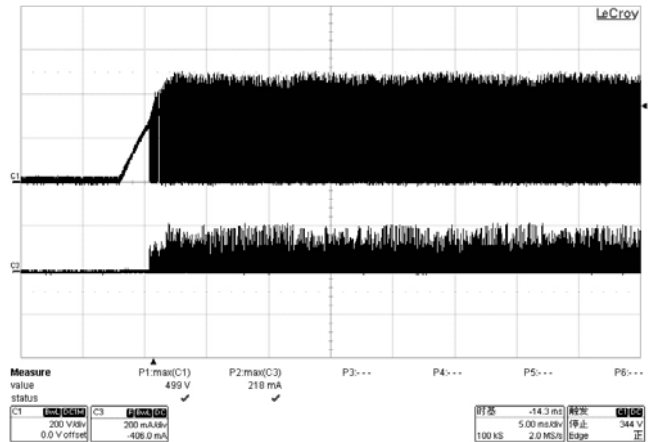


**Figure 17** – 265 VAC, Full Load.  
 Lower:  $I_{DRAIN}$ , 0.2 A / div.  
 Upper:  $V_{DRAIN}$ , 200 V / div., 5  $\mu$ s / div.

### 11.2 Drain Voltage and Current Start-up Profile



**Figure 18** – 90 VAC, Full Load.  
 Lower:  $I_{DRAIN}$ , 0.2 A / div.  
 Upper:  $V_{DRAIN}$ , 200 V, 5ms/ div.



**Figure 19** – 265 VAC, Full Load.  
 Lower:  $I_{DRAIN}$ , 0.2 A / div.  
 Upper:  $V_{DRAIN}$ , 200 V, 5ms/ div.



### 12 Line Surge

Differential ring wave testing was completed on a single test unit, according to EN61000-4-5. Input voltage was set at 230 VAC / 50 Hz. Output was loaded at full load and operation was verified following each surge event.

Surge Level (V)	Input Voltage (VAC)	Injection Location	Injection Phase (°)	Test Result (Pass/Fail)
1000	230	L to N	0	Pass
1000	230	L to N	90	Pass
1000	230	L to N	180	Pass
1000	230	L to N	270	Pass
2000	230	L to N	0	Pass
2000	230	L to N	90	Pass
2000	230	L to N	180	Pass
2000	230	L to N	270	Pass



深圳市华标电子科技有限公司

Bontek Compliance Testing Laboratory Ltd

### Surge Immunity Test Data

编号: TR-4-E-005 Rev:A/0

Standard		<input checked="" type="checkbox"/> EN 61000-4-5 <input type="checkbox"/> IEC 61000-4-5				Result: <input checked="" type="checkbox"/> PASS / <input type="checkbox"/> FAIL					
Applicant: _____ PI _____											
EUT: _____ M/N: _____ GU10 _____											
Repetition: 5 times per test			Interval: 60 seconds			Criteria: <input checked="" type="checkbox"/> B <input type="checkbox"/> C					
Ambient Condition: _____ 25 _____ °C _____ 55 _____ %RH _____ 101 _____ kPa											
Input Voltage: _____ 230 _____ V _____ 50 _____ Hz											
Operation Mode: _____ FULL LOAD _____											
Line: <input checked="" type="checkbox"/> AC Mains <input type="checkbox"/> DC Supply <input type="checkbox"/> Signal Line: Telephone Line											
Conductor	Volt Phase	500V		1.0kV		2.0kV		3.0kV		4.0kV	
		+	-	+	-	+	-	+	-	+	-
L-N	0°			PASS	PASS	PASS	PASS				
	90°			PASS	PASS	PASS	PASS				
	180°			PASS	PASS	PASS	PASS				
	270°			PASS	PASS	PASS	PASS				
L-PE	0°										
	90°										
	180°										
	270°										
N-PE	0°										
	90°										
	180°										
	270°										
L-N-PE	0°										
	90°										
	180°										
	270°										
Telephone Line	L <sub>1</sub> -L <sub>2</sub>										
	L <sub>1</sub> -PE										
	L <sub>2</sub> -PE										

Note:

Test Equipment: SCHAFFNER Model: MODULA6150

Date: 2010.4.30

Test: \_\_\_\_\_

Date: 2010.4.30

Approve: \_\_\_\_\_

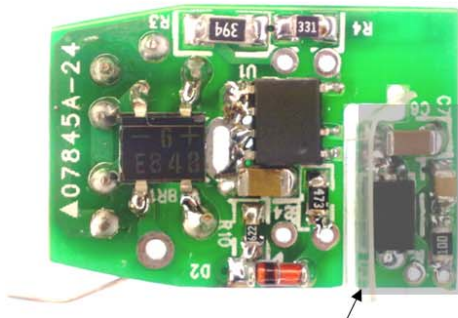


### 13 Hipot Test

The power supply passed a 3 kV AC Hipot test. The potential was applied from the positive terminal of the bridge rectifier to both output terminals (output terminals were shorted together). The potential was applied for 10 seconds.

### 14 ESD Test

ESD(KV)	Test Result
10KV	PASS
11KV	PASS
12KV	PASS
13KV	PASS
14KV	PASS



Note : the assembly has a heat shrinkable tube to cover & protect the entire secondary circuits to meet ESD and Hipot test requirement



### 15 Conducted EMI

Note: Blue line is a peak measurement compared against quasi peak limit line. This represents a very conservative measurement method as actual quasi peak measurements are typically 2-3 dB lower than peak.

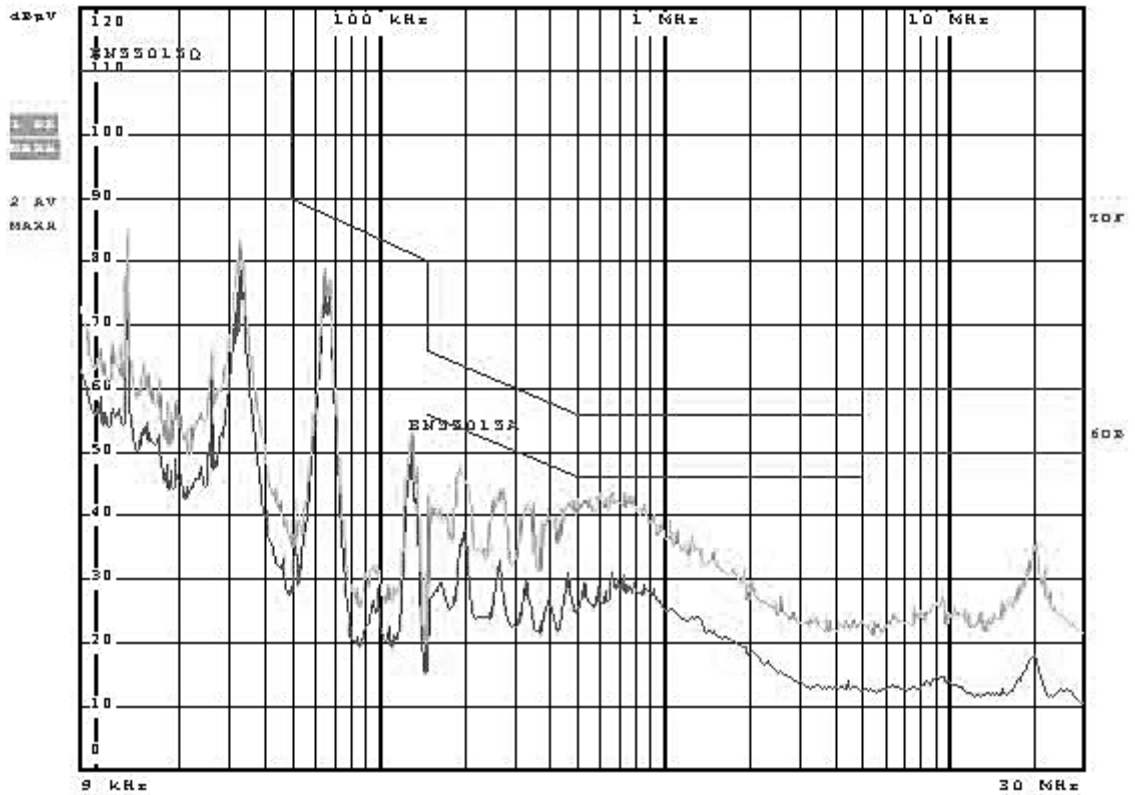


Figure 20 – Conducted EMI, Maximum Steady State Load, 115 VAC, 60 Hz, and EN55015B Limits. Line



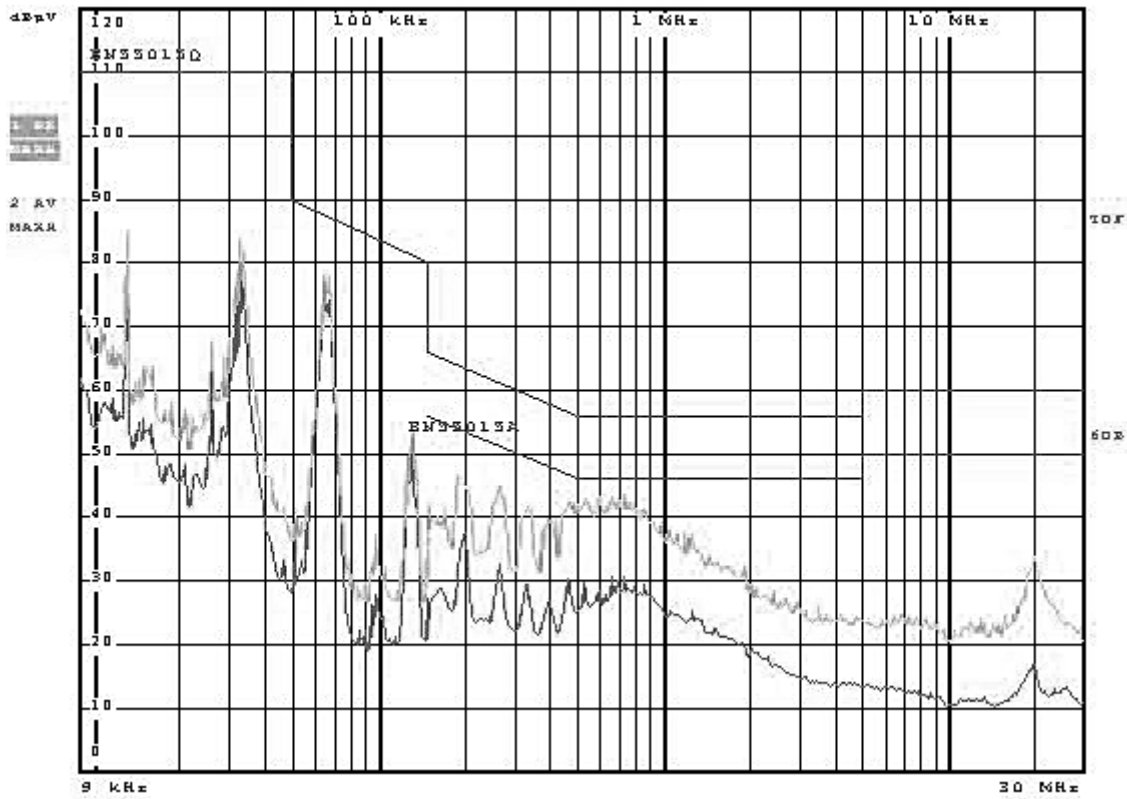


Figure 21 – Conducted EMI, Maximum Steady State Load, 115 VAC, 60 Hz, and EN55015B Limits. Neutral



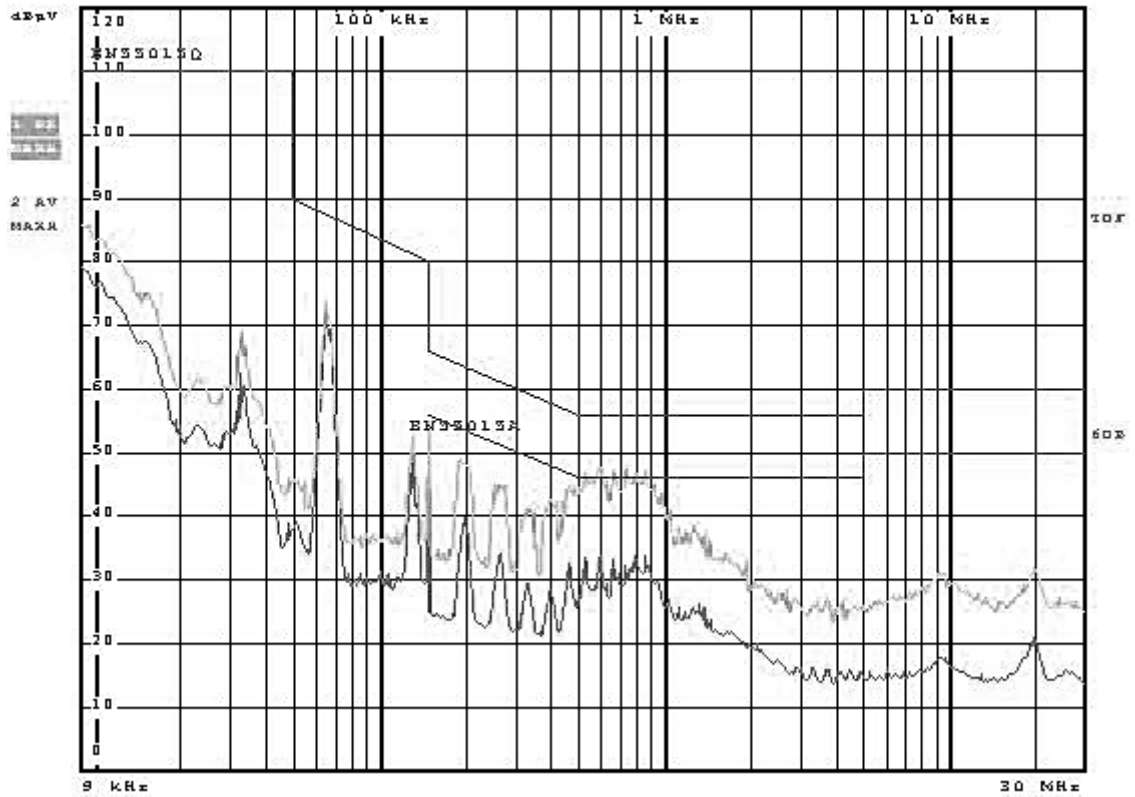


Figure 22 – Conducted EMI, Maximum Steady State Load, 230 VAC, 60 Hz, and EN55015B Limits. Line



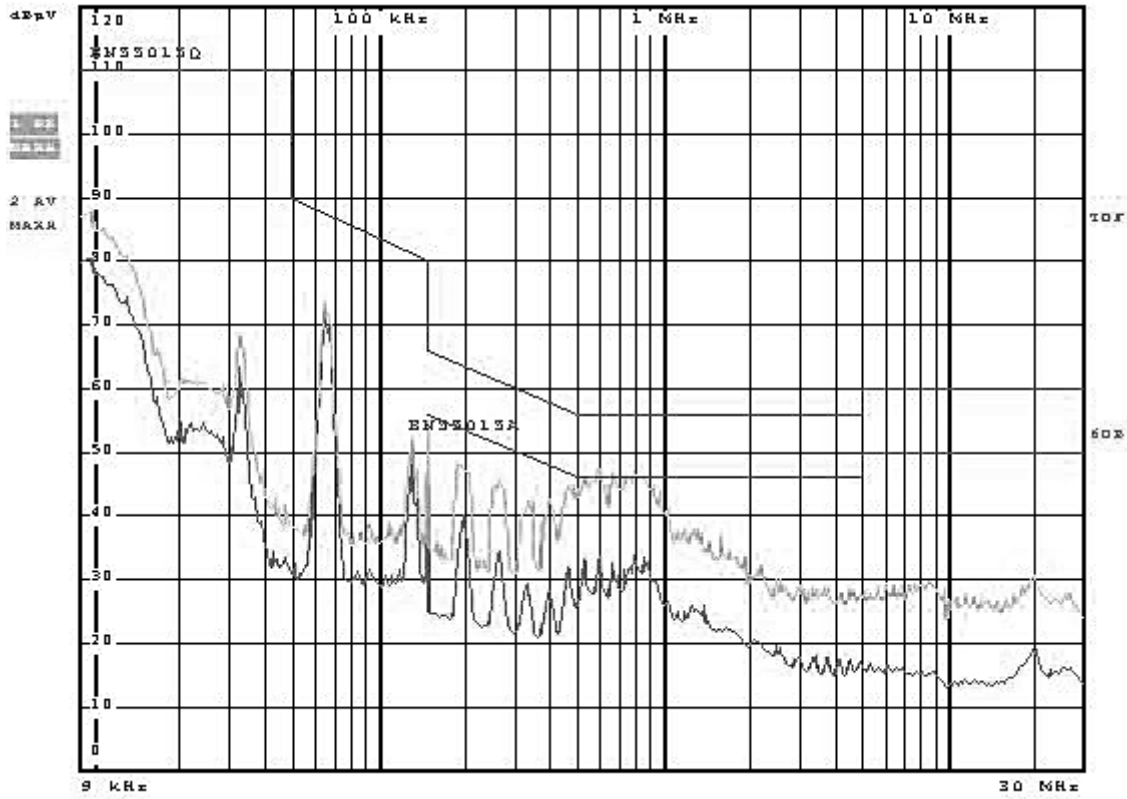


Figure 23 – Conducted EMI, Maximum Steady State Load, 230 VAC, 60 Hz, and EN55015B Limits. Neutral



## 16 Revision History

Date	Author	Revision	Description & changes	Reviewed
24-Sep-10	TH/JY	1.5	Initial Release	Apps and Mktg



---

**For the latest updates, visit our website: [www.powerint.com](http://www.powerint.com)**

Power Integrations reserves the right to make changes to its products at any time to improve reliability or manufacturability. Power Integrations does not assume any liability arising from the use of any device or circuit described herein. POWER INTEGRATIONS MAKES NO WARRANTY HEREIN AND SPECIFICALLY DISCLAIMS ALL WARRANTIES INCLUDING, WITHOUT LIMITATION, THE IMPLIED WARRANTIES OF MERCHANTABILITY, FITNESS FOR A PARTICULAR PURPOSE, AND NON-INFRINGEMENT OF THIRD PARTY RIGHTS.

**PATENT INFORMATION**

The products and applications illustrated herein (including transformer construction and circuits external to the products) may be covered by one or more U.S. and foreign patents, or potentially by pending U.S. and foreign patent applications assigned to Power Integrations. A complete list of Power Integrations' patents may be found at [www.powerint.com](http://www.powerint.com). Power Integrations grants its customers a license under certain patent rights as set forth at <http://www.powerint.com/ip.htm>.

The PI Logo, TOPSwitch, TinySwitch, LinkSwitch, DPA-Switch, PeakSwitch, EcoSmart, Clampless, E-Shield, Filterfuse, StackFET, PI Expert and PI FACTS are trademarks of Power Integrations, Inc. Other trademarks are property of their respective companies. ©Copyright 2010 Power Integrations, Inc.

---

## Power Integrations Worldwide Sales Support Locations

**WORLD HEADQUARTERS**

5245 Hellyer Avenue  
San Jose, CA 95138, USA.  
Main: +1-408-414-9200  
Customer Service:  
Phone: +1-408-414-9665  
Fax: +1-408-414-9765  
*e-mail:*  
[usasales@powerint.com](mailto:usasales@powerint.com)

**GERMANY**

Rueckertstrasse 3  
D-80336, Munich  
Germany  
Phone: +49-89-5527-3911  
Fax: +49-89-5527-3920  
*e-mail:*  
[eurosales@powerint.com](mailto:eurosales@powerint.com)

**JAPAN**

Kosei Dai-3 Building  
2-12-11, Shin-Yokohama,  
Kohoku-ku, Yokohama-shi,  
Kanagawa 222-0033  
Japan  
Phone: +81-45-471-1021  
Fax: +81-45-471-3717  
*e-mail:* [japansales@powerint.com](mailto:japansales@powerint.com)

**TAIWAN**

5F, No. 318, Nei Hu Rd., Sec. 1  
Nei Hu District  
Taipei 114, Taiwan R.O.C.  
Phone: +886-2-2659-4570  
Fax: +886-2-2659-4550  
*e-mail:*  
[taiwansales@powerint.com](mailto:taiwansales@powerint.com)

**CHINA (SHANGHAI)**

Rm 1601/1610, Tower 1  
Kerry Everbright City  
No. 218 Tianmu Road West  
Shanghai, P.R.C. 200070  
Phone: +86-021-6354-6323  
Fax: +86-021-6354-6325  
*e-mail:*  
[chinasales@powerint.com](mailto:chinasales@powerint.com)

**INDIA**

#1, 14<sup>th</sup> Main Road  
Vasanthanagar  
Bangalore-560052  
India  
Phone: +91-80-4113-8020  
Fax: +91-80-4113-8023  
*e-mail:*  
[indiasales@powerint.com](mailto:indiasales@powerint.com)

**KOREA**

RM 602, 6FL  
Korea City Air Terminal B/D, 159-6  
Samsung-Dong, Kangnam-Gu,  
Seoul, 135-728  
Korea  
Phone: +82-2-2016-6610  
Fax: +82-2-2016-6630  
*e-mail:* [koreasales@powerint.com](mailto:koreasales@powerint.com)

**UNITED KINGDOM**

1st Floor, St. James's House  
East Street,  
Farnham Surrey, GU9 7TJ  
United Kingdom  
Phone: +44 (0) 1252-730-141  
Fax: +44 (0) 1252-727-689  
*e-mail:*  
[eurosales@powerint.com](mailto:eurosales@powerint.com)

**CHINA (SHENZHEN)**

Rm A, B & C 4<sup>th</sup> Floor, Block C,  
Electronics Science and  
Technology Building  
2070 Shennan Zhong Road  
Shenzhen, Guangdong,  
P.R.C. 518031  
Phone: +86-755-8379-3243  
Fax: +86-755-8379-5828  
*e-mail:*  
[chinasales@powerint.com](mailto:chinasales@powerint.com)

**ITALY**

Via De Amicis 2  
20091 Bresso MI  
Italy  
Phone: +39-028-928-6000  
Fax: +39-028-928-6009  
*e-mail:*  
[eurosales@powerint.com](mailto:eurosales@powerint.com)

**SINGAPORE**

51 Newton Road,  
#15-08/10 Goldhill Plaza  
Singapore, 308900  
Phone: +65-6358-2160  
Fax: +65-6358-2015  
*e-mail:*  
[singaporesales@powerint.com](mailto:singaporesales@powerint.com)

**APPLICATIONS HOTLINE**

World Wide +1-408-414-9660

**APPLICATIONS FAX**

World Wide +1-408-414-9760

