

Design Example Report

Title	<i>15 W, Universal Input, Tube LED Driver Using LYTSwitch™-5 LYT5216D</i>
Specification	100 VAC – 277 VAC Input; 80 V _{TYP} , 188 mA _{TYP} Output
Application	LED Tube (Compatible with Magnetic and Electronic Ballasts)
Author	Applications Engineering Department
Document Number	DER-596
Date	February 6, 2017
Revision	1.0

Summary and Features

- Magnetic and electronic ballast compatible with universal input
- Single-stage buck-boost topology power factor corrected, PF >0.9
- Accurate constant current regulation, ±5%
- Highly energy efficient, >89% at 230 VAC
- Low %THD, <10% at 230 VAC, <5% at 120 VAC
- Low component count for compact PCB solution
- Integrated protection features
 - No-load output protection
 - Output short-circuit protection
 - Overcurrent protection
 - Thermal fold-back and over temperature shutdown
 - No damage during line brown-out or brown-in conditions
- Meets IEC 2.5 kV ring wave, 1 kV differential surge
- Meets EN55015 conducted EMI

PATENT INFORMATION

The products and applications illustrated herein (including transformer construction and circuits external to the products) may be covered by one or more U.S. and foreign patents, or potentially by pending U.S. and foreign patent applications assigned to Power Integrations. A complete list of Power Integrations' patents may be found at www.powerint.com. Power Integrations grants its customers a license under certain patent rights as set forth at <http://www.powerint.com/ip.htm>.

Power Integrations

5245 Hellyer Avenue, San Jose, CA 95138 USA.
Tel: +1 408 414 9200 Fax: +1 408 414 9201
www.power.com

Table of Contents

1	Introduction	4
2	Power Supply Specification	6
3	Schematic	7
4	Circuit Description	8
4.1	Input Stage	8
4.2	EMI Filter	8
4.3	LYTSwitch-5 Control Circuit	8
5	PCB Layout	10
6	Bill of Materials	11
7	Inductor Specification	12
7.1	Electrical Diagram	12
7.2	Electrical Specifications	12
7.3	Material List	12
7.4	Inductor Build Diagram	13
7.5	Inductor Construction	13
8	Inductor Design Spreadsheet	14
9	Performance Data	16
9.1	Efficiency	16
9.2	Line Regulation	17
9.3	Regulation with Electronic and Magnetic Ballasts	18
9.4	Power Factor	19
9.5	%ATHD	20
9.6	Individual Harmonics Content	21
9.6.1	115 VAC, 60 Hz	21
9.6.2	230 VAC, 50 Hz	22
10	Test Data	23
10.1	Test Data, 80 V LED Load	23
10.2	Test Data, Harmonic Content at 115 VAC, 80 V LED Load	23
10.3	Test Data, Harmonic Content at 230 VAC, 80 V LED Load	24
11	Thermal Performance	25
11.1	Thermal Performance Scan	25
12	Waveforms	27
12.1	Input Voltage and Input Current Waveforms	27
12.2	Input Voltage and Input Current Waveforms – Electronic Ballast	28
12.3	Input Voltage and Input Current Waveforms – Magnetic Ballast	29
12.4	Start-up Profile	30
12.5	Output Current Fall	31
12.6	Drain Voltage and Current in Normal Operation	32
12.7	Drain Voltage and Current Start-up Profile	34
12.8	Drain Voltage and Current During Output Short-Circuit	35
12.9	Output Diode Voltage and Current in Normal Operation	36
12.10	Output Voltage and Current – Open Output LED Load	38



12.11	Output Voltage and Current – Start-up at Open Output Load	38
12.12	Output Ripple Current.....	39
13	AC Cycling Test.....	40
14	Conducted EMI	41
14.1	Test Set-up	41
14.1.1	Equipment and Load Used	41
14.2	EMI Test Result	42
15	Line Surge	44
16	Brown-in / Brown-out Test	45
17	Revision History	46

Important Note: Although this board is designed to satisfy safety isolation requirements, the engineering prototype has not been agency approved. Therefore, all testing should be performed using an isolation transformer to provide the AC input to the prototype board.





Figure 2 – Populated Circuit Board, Top View.



Figure 3 – Populated Circuit Board, Bottom View.

2 Power Supply Specification

The table below represents the minimum acceptable performance of the design. Actual performance is listed in the results section.

Description	Symbol	Min	Typ	Max	Units	Comment
Input Voltage Frequency	V_{IN} f_{LINE}	100	115/230 60/50	277	VAC Hz	2 Wire – no P.E.
Output Output Voltage Output Current Total Output Power Continuous Output Power	V_{OUT} I_{OUT} P_{OUT}		80 188 15		V mA W	
Efficiency Full Load	η		89		%	115 V / 60 Hz at 25 °C.
Environmental Conducted EMI Safety Ring Wave (100 kHz) Differential Mode (L1-L2)			CISPR 15B / EN55015B Isolated 2.5 1.0		kV kV	
Power Factor			0.9			Measured at 115/230 VAC 50/60 Hz.
Ambient Temperature	T_{AMB}			70	°C	Free Convection, Sea Level.

3 Schematic

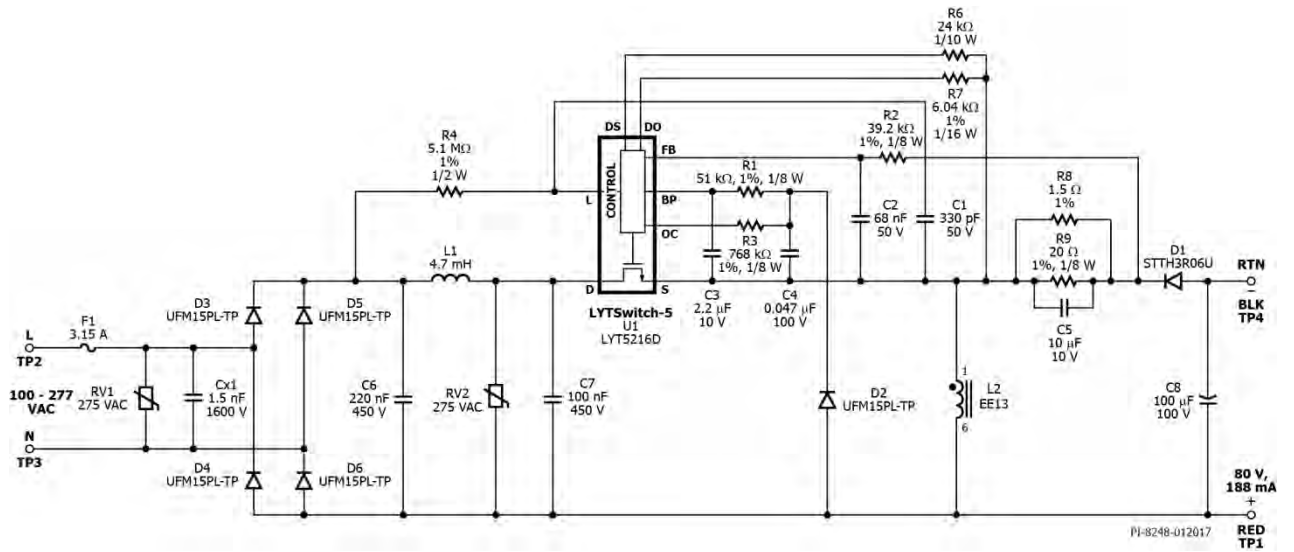

Figure 4 – Schematic.



4 Circuit Description

The LYTSwitch-5 (LYT5216D) IC combines a high-voltage power MOSFET switch with a power supply controller in a single package. The LYTSwitch-5 controller provides a single-stage power factor correction, LED current control.

4.1 Input Stage

Input fuse F1 provides protection against component failure. Varistors RV1 and RV2 are used to protect the LED driver against lightning surges. The varistor is chosen to limit the LYT5216D Drain voltage below 650 V. The full wave bridge rectifier D3, D4, D5, and D6 provides good power factor and low total harmonic distortion. The input rectifier diodes were chosen to be ultrafast diodes for electronic ballast compatibility. The input rectifiers with CX1 ensure driver compatibility with electronic ballasts.

4.2 EMI Filter

After the rectified AC input voltage an EMI π filter circuit is cascaded. The circuit is composed of a differential choke inductor L1 and input filter capacitors C6 and C7. The EMI filter, together with the LYTSwitch-5 IC electronically quiet SOURCE (S) pins and frequency jitter provide substantial EMI margin.

4.3 LYTSwitch-5 Control Circuit

The topology is a high-side, non-isolated buck-boost converter. During turn-on of the LYT5216D internal MOSFET, current ramps through buck-boost inductor (L2). Output diode (D1) is reverse biased during the LYTSwitch-5 on time. Once the LYTSwitch-5 power MOSFET turns off, the buck-boost inductor reverses polarity and biases the output diode. The energy stored in the inductor is delivered to the load. Output capacitor (C8) provides filtering to limit the output current ripple.

During start-up the bypass capacitor (C3) is charged to 5.25 V from an internal high-voltage current source internally fed from the DRAIN (D) pin of the LYTSwitch-5 IC. Once at normal operating conditions, the LYTSwitch-5 bias supply is provided by the circuit consisting of D2, C4 and R1. Bias voltage is taken directly from the output which results in a low cost and simple inductor design. The value of R1 is chosen to provide the required drain supply current specified in the data sheet.

LYTSwitch-5 ICs provide excellent output current regulation through the FEEDBACK (FB) pin. The output current is directly sampled through the parallel combination of R8 and R9. The voltage across the sense resistors is compared to the reference voltage of 300 mV to regulate the output current. Capacitor (C5) is used to filter the sense voltage across the sense resistors. Resistor R2 and C2 form a low pass filter which reduces high frequency noise at the FB pin.

The OUTPUT COMPENSATION (OC) pin when used in a direct sensed topology is used solely for output OVP protection. Resistor R3 provides filtering to the OC pin signal.



Resistor (R4) connected to the LINE SENSE PIN (L) to measure the input voltage. Input overvoltage is triggered when the input overvoltage current threshold flowing to the L PIN is exceeded. Filter capacitor (C1) connected between the LINE (L) and SOURCE (S) pins provide noise filtering from falsely triggering input overvoltage.

The DRIVER CURRENT SENSE (DS) pin when used in a direct sensed topology should be connected to the source pin via a 24 k Ω resistor. The DATA OUTPUT (DO) pin should be connected to source via a 6 k Ω resistor. As an added feature, the DO pin provides fault information during auto-restart events.



5 PCB Layout

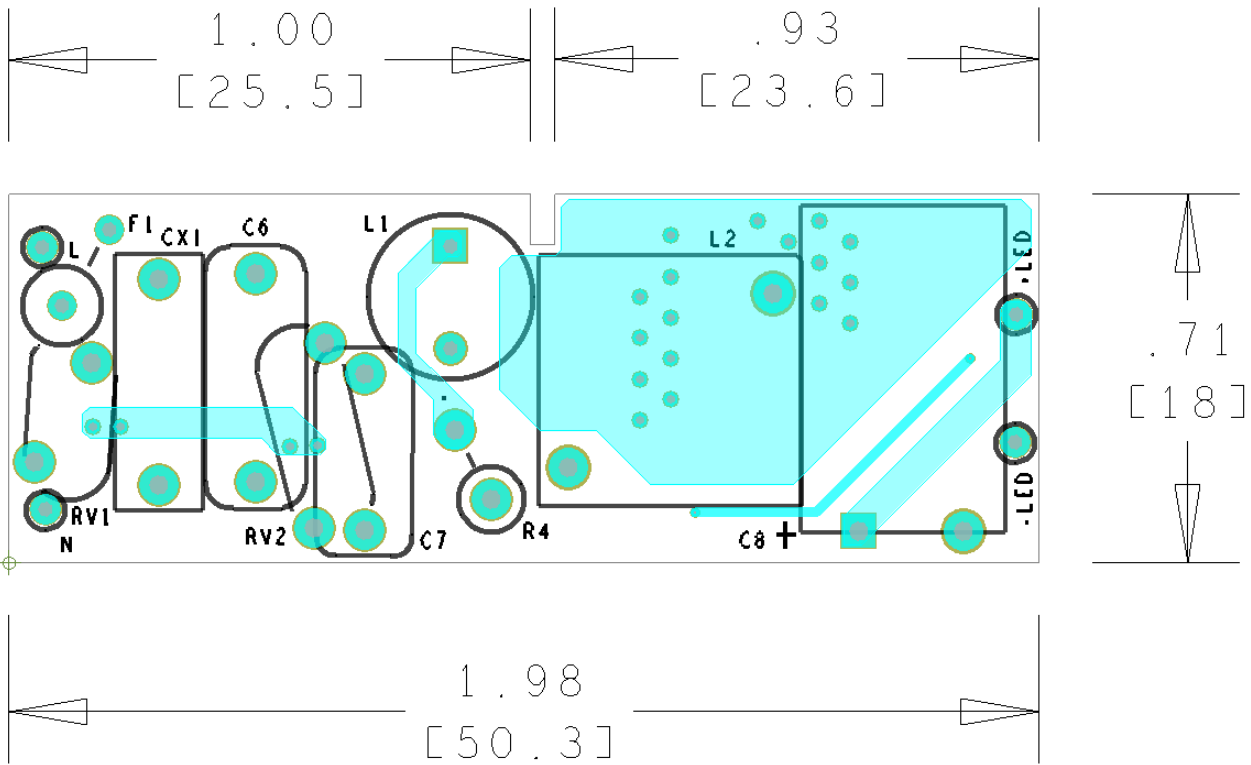

Figure 5 – Top Side.

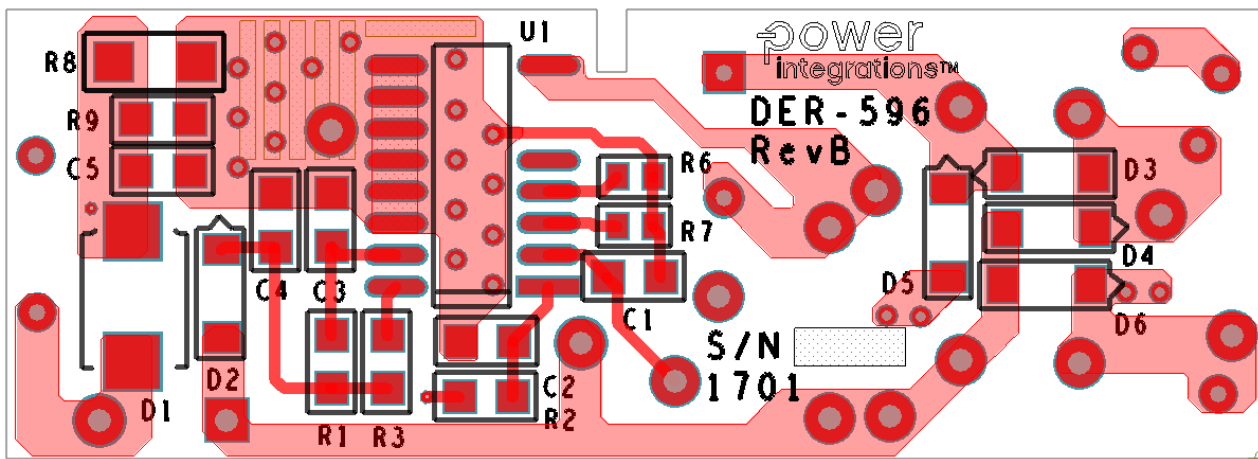

Figure 6 – Bottom Side.

6 Bill of Materials

Item	Qty	Ref Des	Description	Mfg Part Number	Mfg
1	1	C1	330 pF, 50 V, Ceramic, NPO, 0805	CC0805JRNPO9BN331B	Yageo
2	1	C2	68 nF, 50 V, Ceramic, X7R, 0805	C0805C683K5RACTU	Kemet
3	1	C3	2.2 μ F, 10 V, Ceramic, X7R, 0805	C0805C225M8RACTU	Kemet
4	1	C4	0.047 μ F, \pm 10%, 100V, Ceramic, X7R, 0805	GCM21BR72A473KA37L	Murata
5	1	C5	10 μ F, 10 V, Ceramic, X7R, 0805	C2012X7R1A106M	TDK
6	1	C6	220 nF, 450 V, Film	MEXXF32204JJ	Duratech
7	1	C7	100 nF, 450 V, Film	MEXXD31004JJ1	Duratech
8	1	C8	100 μ F, 100 V Aluminum ,Radial, Can, 2k Hrs @ 105 °C	EKMQ101ELL101MJ16S	United Chemi-Con
9	1	CX1	1.5 nF, 1600 V VDC, Film	B32671L1152J000	Epcos
10	1	D1	600 V, 3 A, Fast Recovery, 35 ns, SMB Case	STTH3R06U	ST Micro
11	1	D2	600 V, 1 A, Ultrafast Recovery, 75 ns, SOD-123	UFM15PL-TP	Micro Commercial
12	1	D3	600 V, 1 A, Ultrafast Recovery, 75 ns, SOD-123	UFM15PL-TP	Micro Commercial
13	1	D4	600 V, 1 A, Ultrafast Recovery, 75 ns, SOD-123	UFM15PL-TP	Micro Commercial
14	1	D5	600 V, 1 A, Ultrafast Recovery, 75 ns, SOD-123	UFM15PL-TP	Micro Commercial
15	1	D6	600 V, 1 A, Ultrafast Recovery, 75 ns, SOD-123	UFM15PL-TP	Micro Commercial
16	1	F1	3.15 A, 250 V, Slow, 3.6 mm x 10 mm, Axial	08773.15MXEP	Littlefuse
17	1	L1	4.7 mH, 240 mA, 9 x 12.2 mm H	RLB9012-472KL	Bourns
18	1	L2	Bobbin, EE13, Vertical, 10 pins	P-1302-2	Pin Shine
19	1	R1	RES, 51 k Ω , 5%, 1/8 W, Thick Film, 0805	ERJ-6GEYJ513V	Panasonic
20	1	R2	RES, 39.2 k Ω , 1%, 1/8 W, Thick Film, 0805	ERJ-6ENF3922V	Panasonic
21	1	R3	RES, 768 k Ω , 1%, 1/8 W, Thick Film, 0805	ERJ-6ENF7683V	Panasonic
22	1	R4	RES, 5.1 M Ω , 1%, 1/2 W, Metal Film	HVR3700005104FR500	Vishay
23	1	R6	RES, 24 k Ω , 5%, 1/10 W, Thick Film, 0603	ERJ-3GEYJ243V	Panasonic
24	1	R7	RES, 6.04 k Ω , 1%, 1/16 W, Thick Film, 0603	ERJ-3EKF6041V	Panasonic
25	1	R8	RES, 1.5 Ω , 1%, 1/4 W, Thick Film, 1206	ERJ-8GEYJ1R5V	Panasonic
26	1	R9	RES, 20 Ω , 1%, 1/8 W, Thick Film, 0805	ERJ-6ENF20R0V	Panasonic
27	1	RV1	275 Vac, 23 J, 7 mm, RADIAL	V275LA4P	Littlefuse
28	1	RV2	275 Vac, 23 J, 7 mm, RADIAL	V275LA4P	Littlefuse
29	1	U1	LYTSwitch-5, SO-16B, Low voltage	LYT5216D	Power Integrations

7 Inductor Specification

7.1 Electrical Diagram

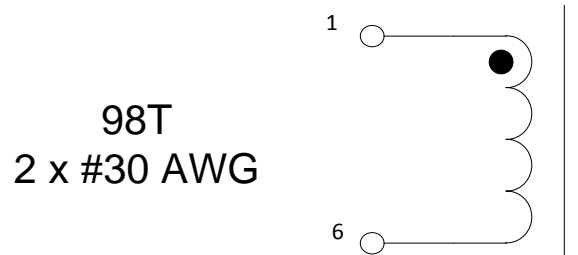

Figure 7 – Inductor Electrical Diagram.

7.2 Electrical Specifications

Parameter	Condition	Spec.
Nominal Primary Inductance	Measured at $1 V_{PK-PK}$, 100 kHz switching frequency, between pin 1 and pin 6.	300 μ H
Tolerance	Tolerance of primary inductance.	$\pm 5\%$

7.3 Material List

Item	Description
[1]	Core: EE13.
[2]	Bobbin: EE13, Vertical, 10 pins.
[3]	Magnet Wire: #30 AWG.
[4]	Transformer Tape: 7.5 mm.
[5]	Transformer Tape: 6.0 mm.

7.4 Inductor Build Diagram

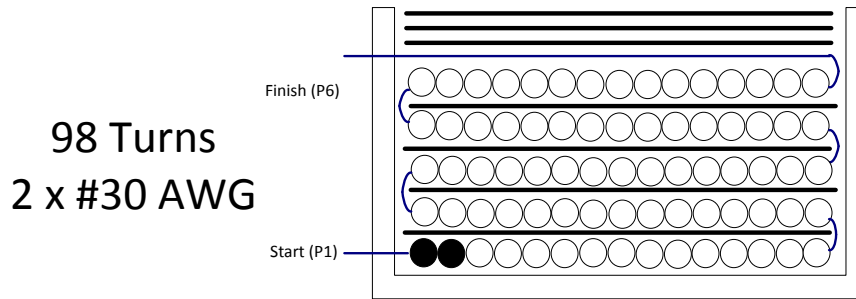

Figure 8 – Inductor Electrical Diagram.

7.5 Inductor Construction

Winding Directions	Bobbin is oriented on winder jig such that terminal pin 1-5 is on the left side. The winding direction is counter clockwise.
Winding 1	Use wire item [3], start at pin 1 and wind 98 turns. Add item [4] interlayer tape after every layer. On the last layer spread winding evenly across the bobbin width. Terminate the winding on pin 6.
Insulation	Add 3 layers of tape, Item [4], for insulation.
Core Grinding	Grind the center leg of one core until it meets the nominal inductance of 300 μ H.
Assemble Core	Assemble the 2 core halves on the bobbin and wrap with 3 layers of tape, item (5).
Fix Core	Wrap item [4] tape around core and winding to prevent core from moving.
Pins	Pull out terminal pin no. 2, 3, 4, 5, 7, 8, 9 and 10.
Finish	Dip the transformer assembly in varnish.

8 Inductor Design Spreadsheet

ACDC_LYTSwitch5_BuckBoost_080516 ; Rev.1.0; Copyright Power Integrations 2016	INPUT	INFO	OUTPUT	UNITS	LYTSwitch-5 Buck-Boost Design Spreadsheet
ENTER APPLICATION VARIABLES					
VACMIN	100.0		100.0	Volts RMS	Minimum AC line voltage.
VACNOM	230.0		230.0	Volts RMS	Nominal AC line voltage.
VACMAX	277.0		277.0	Volts RMS	Maximum AC line voltage.
FL			50	Hertz	AC line frequency.
VO_MIN			72.0	Volts DC	Guaranteed minimum VO that maintains output regulation.
VO	80.0		80.0	Volts DC	Worst case normal operating output voltage.
VO_OVP_MIN			90.7	Volts DC	Minimum Voltage at which output voltage protection may be activated.
IO	188.0		188.0	m-Amperes	Average output current specification.
EFFICIENCY	0.90		0.90	Dimensionless	Total power supply efficiency.
Z			0.50	Dimensionless	Loss allocation factor.
PO			15.04	Watts	Output power.
LYTSwitch-5 DESIGN VARIABLES					
BREAKDOWN VOLTAGE	650	Info	650	Volts DC	VACMAX may be too high during surge. Please check on the bench, or choose 725V variant.
GENERIC DEVICE	Auto		LYT52X6D		Chosen LYTSwitch-5 generic device.
ACTUAL DEVICE			LYT5216D		Chosen LYTSwitch-5 device code.
ILIMITMIN			1.767	Amperes	Minimum device current limit.
ILIMITTYP			1.900	Amperes	Typical Current Limit.
ILIMITMAX			2.033	Amperes	Maximum Current Limit.
IP_MOSFET			1.742	Amperes	Worst case peak drain current of the MOSFET.
TON_MIN			1.207	u-seconds	Worst case minimum on-time of the MOSFET.
TON_MAX			3.030	u-seconds	Worst case maximum on-time of the MOSFET.
I AVG_MOSFET			0.158	Amperes	Worst case average drain current of the MOSFET.
IRMS_MOSFET			0.343	Amperes	Worst case maximum RMS current of the MOSFET.
KDP			1.130	Dimensionless	Ratio between off-time of the MOSFET and on-time of the secondary diode.
VDRAIN			513.1	Volts DC	Estimated worst case drain voltage of the MOSFET.
DEVICE PROGRAMMING PARAMETERS					
RDO			6	k-ohms	DO pin resistor.
RDS			6	k-ohms	Current sense programming resistor connected to the DS pin for the buck-boost converter.
ENTER INDUCTOR CORE/CONSTRUCTION VARIABLES					
CORE TYPE	EE13		EE13		Core type.
AE			17.10	mm ²	Core effective cross sectional area.
LE			30.20	mm	Core effective path length.
AL			1130	nH/T ²	Ungapped core effective inductance.
VE			517	mm ³	Core volume.
AW			18.43	mm ²	Window area of the bobbin.
BW			7.60	mm	Bobbin physical winding width.
TRANSFORMER DESIGN PARAMETERS					
Inductance parameters					
INDUCTANCE	300		300	u-Henrys	Typical value of inductance.
INDUCTOR_TOL	5		5	%	Tolerance of inductance.
INDUCTANCE_MIN			285	u-Henrys	Minimum value of inductance.
INDUCTANCE_MAX			315	u-Henrys	Maximum value of inductance.
N	98		98	Turns	Number of inductor turns.
ALG			31.24	nH/T ²	Gapped core effective inductance.
BM			3274	Gauss	Maximum flux density.
BP			3821	Gauss	Peak flux density.
BAC			1637	Gauss	Worst case AC Flux Density for Core Loss Curves (0.5 X Peak to Peak).



LG			0.7	mm	Core gap length.
LAYERS_DESIRED			5	Dimensionless	Desired number of inductor's winding layers.
LAYERS_ACTUAL			4.84	Dimensionless	Actual number of inductor's winding layers.
AWG			28	AWG	Inductor's wire gauge.
OD_INDUCTOR_INSULATED			0.375	mm	Outer diameter of the inductor winding wire with insulation.
OD_INDUCTOR_BARE			0.321	mm	Outer diameter of the inductor winding wire without insulation.
IRMS_INDUCTOR			0.522	Amperes	Maximum RMS current flowing through the inductor's winding.
CMA_INDUCTOR			306	Cmils/A	Inductor winding CMA.
J_INDUCTOR			6.45	A/mm ²	Inductor Winding Current density.
PRIMARY WINDING FILL FACTOR			75%	Dimensionless	Percentage of bobbin window filled up by the inductor winding.
Bias winding parameters					
VD_BIAS			0.70	Volts DC	Bias winding diode forward drop voltage.
BIAS_TURNS			16	Turns	Number of bias winding turns.
VBIAS			12.0	Volts DC	Bias Voltage. Check performance at minimum VO and VACMAX.
PIVBS			76.0	Volts DC	Output Rectifier Maximum Peak Inverse Voltage (calculated at VACMAX)
CBIAS			22.0	u-Farads	Bias winding rectification capacitor.
RBP			7.00	k-Ohms	Bias supply resistor assuming 1mA current necessary to supply the BP pin.
CBP			2.2	u-Farads	Minimum BP pin capacitance.
SECONDARY DIODE PARAMETERS					
VF_DIODE			0.7	Volts DC	Output diode forward voltage drop.
IRMS_DIODE			0.434	Amperes	Diode RMS current at LP_MIN, VACMIN and PO_MAX.
IP_DIODE			1.742	Amperes	Diode peak current at LP_MIN, VACMAX and PO_MAX.
PIV_DIODE			530.6	Volts DC	Peak Inverse Voltage at VO_MAX on output diode.
FEEDBACK AND PROTECTION PARAMETERS WITH FINE TUNING					
RL	5.10		5.10	M-Ohms	Standard (E96 / 1%) L pin resistor.
OVP_LINE			432.7	Volts RMS	Line overvoltage based on the actual L pin resistor used.
RDC_THEORETICAL			2.54	Ohms	Theoretical DS pin sense resistor.
RDC			2.55	Ohms	Standard (E96 / 1%) DS pin sense resistor.
CDC			10.0	u-Farads	Standard capacitor connected in parallel with the DS pin sense resistor.
VBIAS_MEASURED			12.0	Volts DC	Actual bias voltage (across the bias capacitor) measured on the bench.
VO_MEASURED			80.0	Volts DC	Actual load voltage measured on the bench.
ROC			100.0	k-Ohms	Standard (E96 / 1%) OC pin resistor.
IO_ACTUAL			188.0	m-Amperes	Actual output current seen on the bench.
RFB_THEORETICAL			51.7	k-Ohms	Calculated value of RFB, using standard values for RDS, ROVP, and RL
RFB			52.3	k-Ohms	Standard (E96 / 1%) F pin resistor.
CFB			120.0	n-Farads	Standard capacitor connected to the F pin.

9 Performance Data

All measurements were performed at room temperature using LED load. 1 minute soak time was applied before measurement with AC source turned-off for 5 seconds every succeeding input line measurement.

9.1 Efficiency

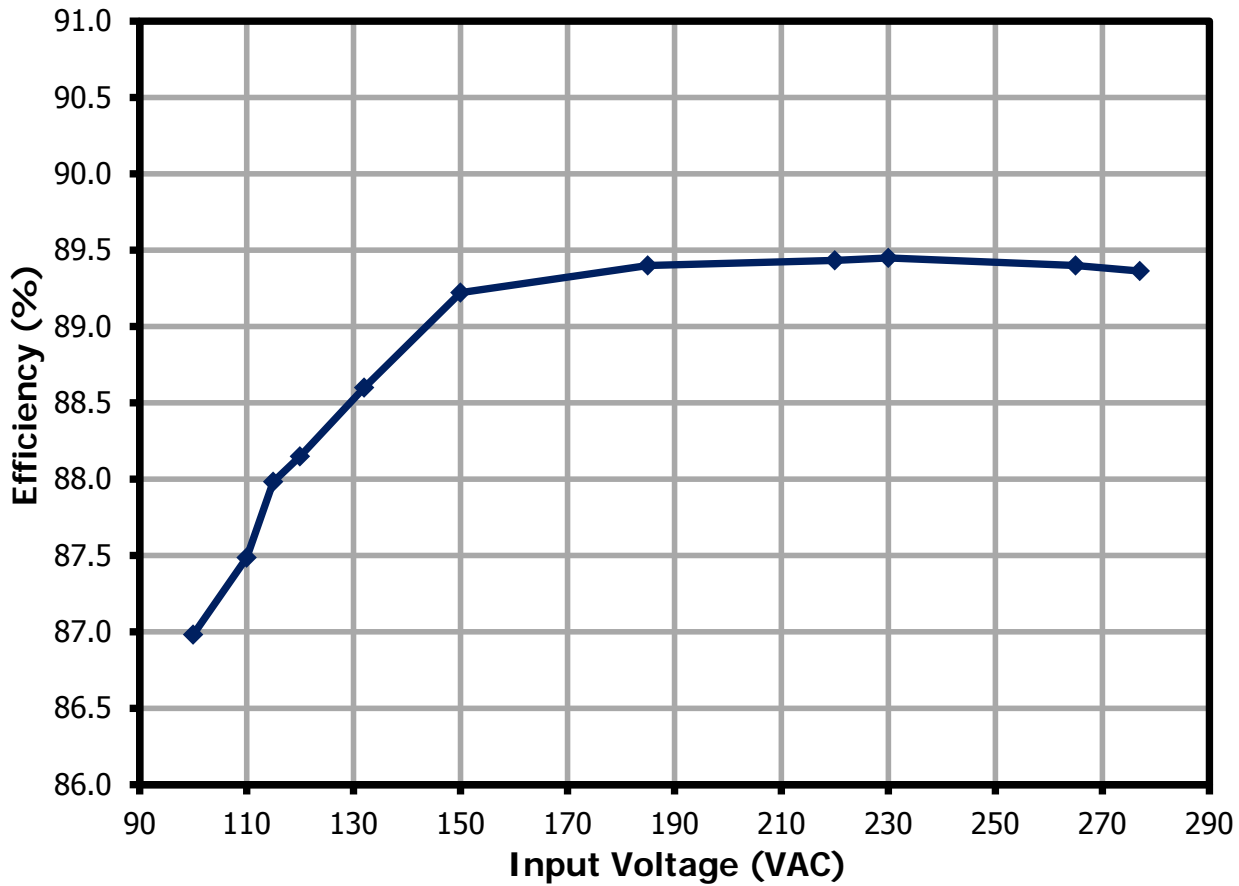

Figure 9 – Efficiency vs. Line.

9.2 Line Regulation

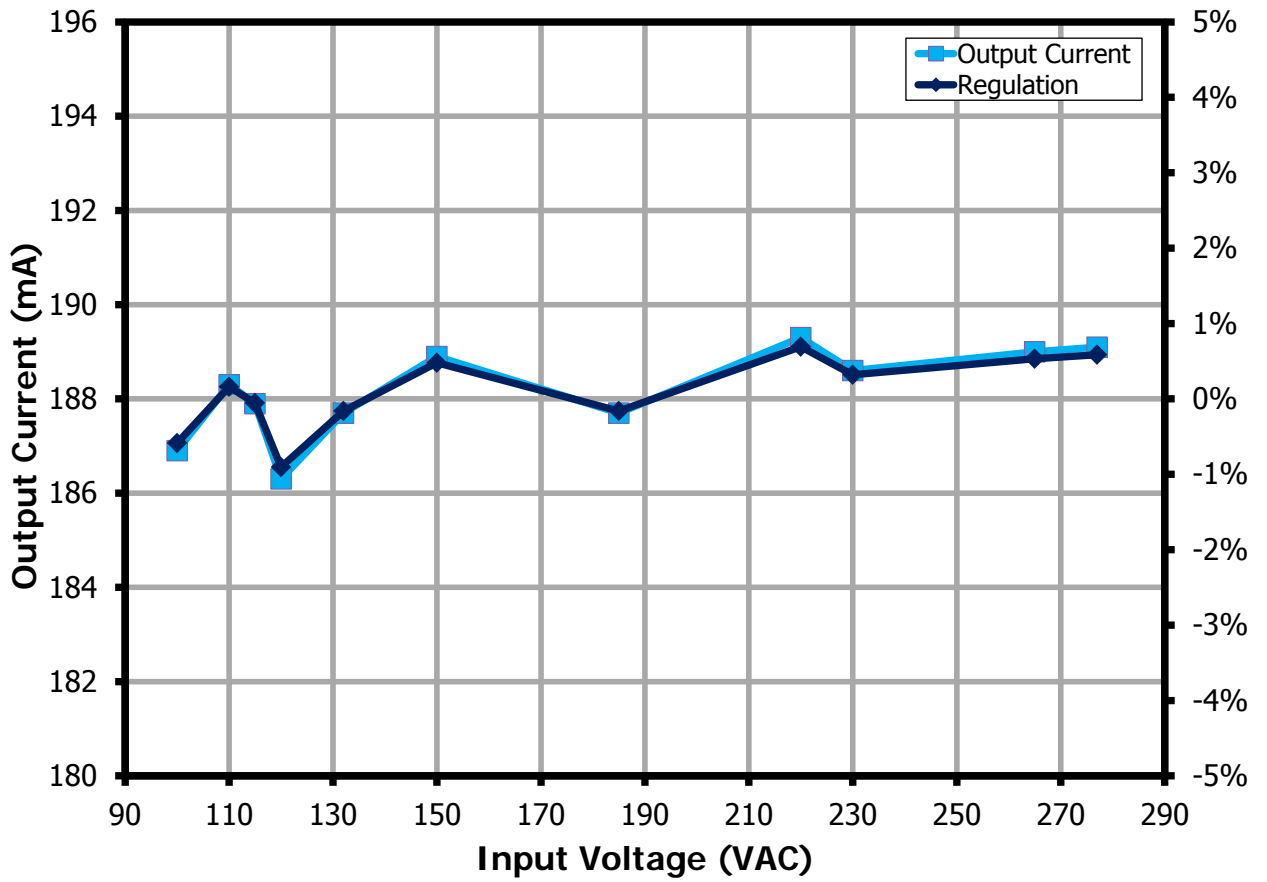

Figure 10 – Regulation vs. Line.



9.3 Regulation with Electronic and Magnetic Ballasts

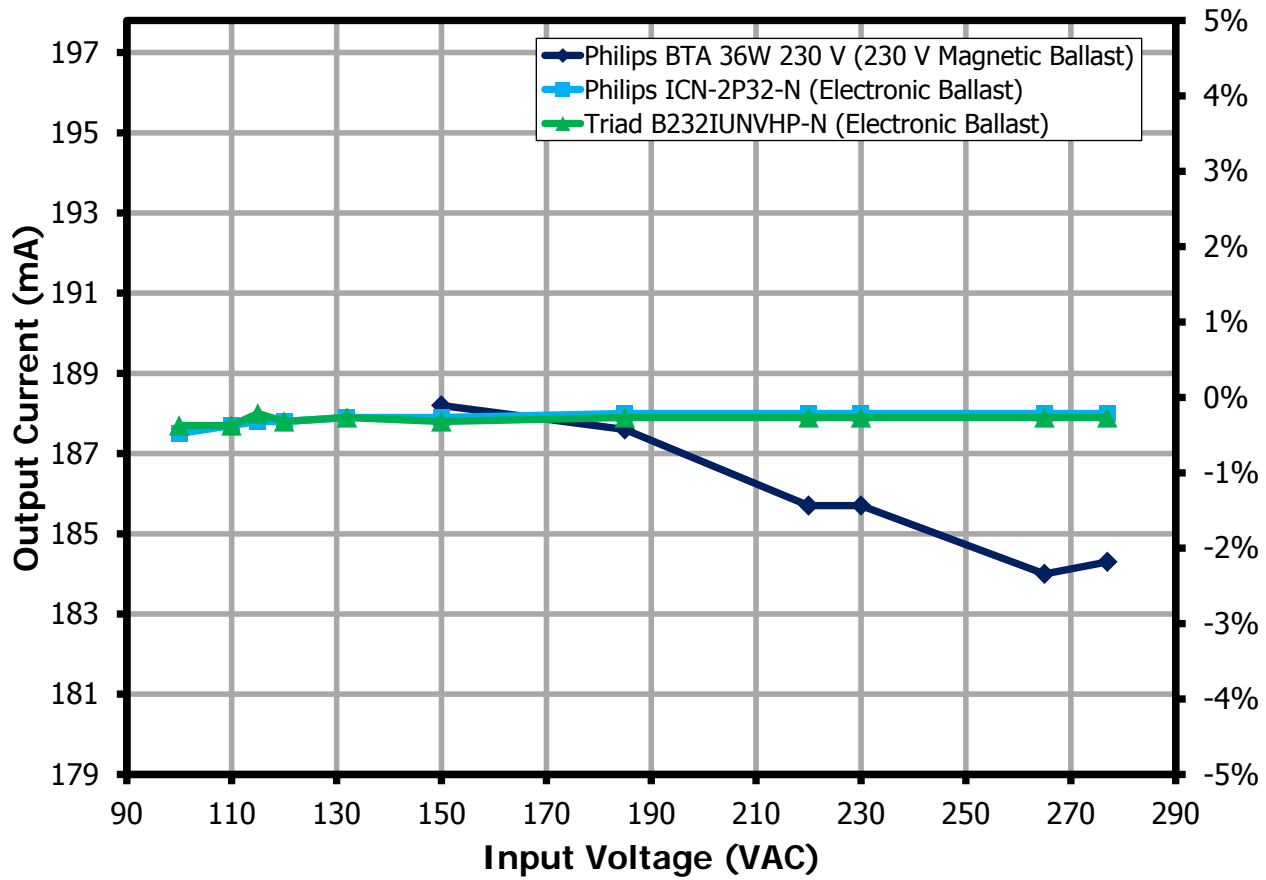

Figure 11 – Output Current vs. Input Voltage with Different Ballasts.

9.4 Power Factor

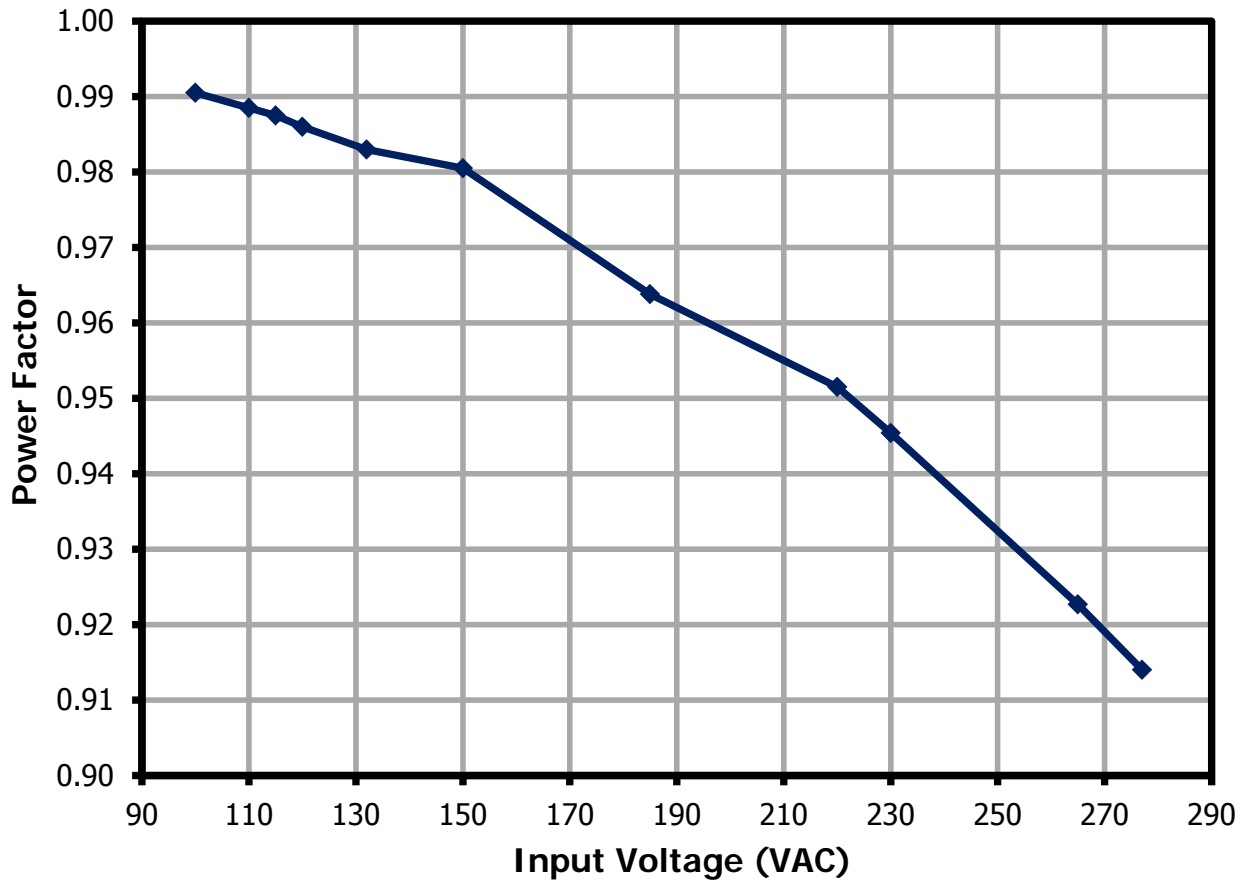

Figure 12 – Power Factor vs. Line.



9.5 %ATHD

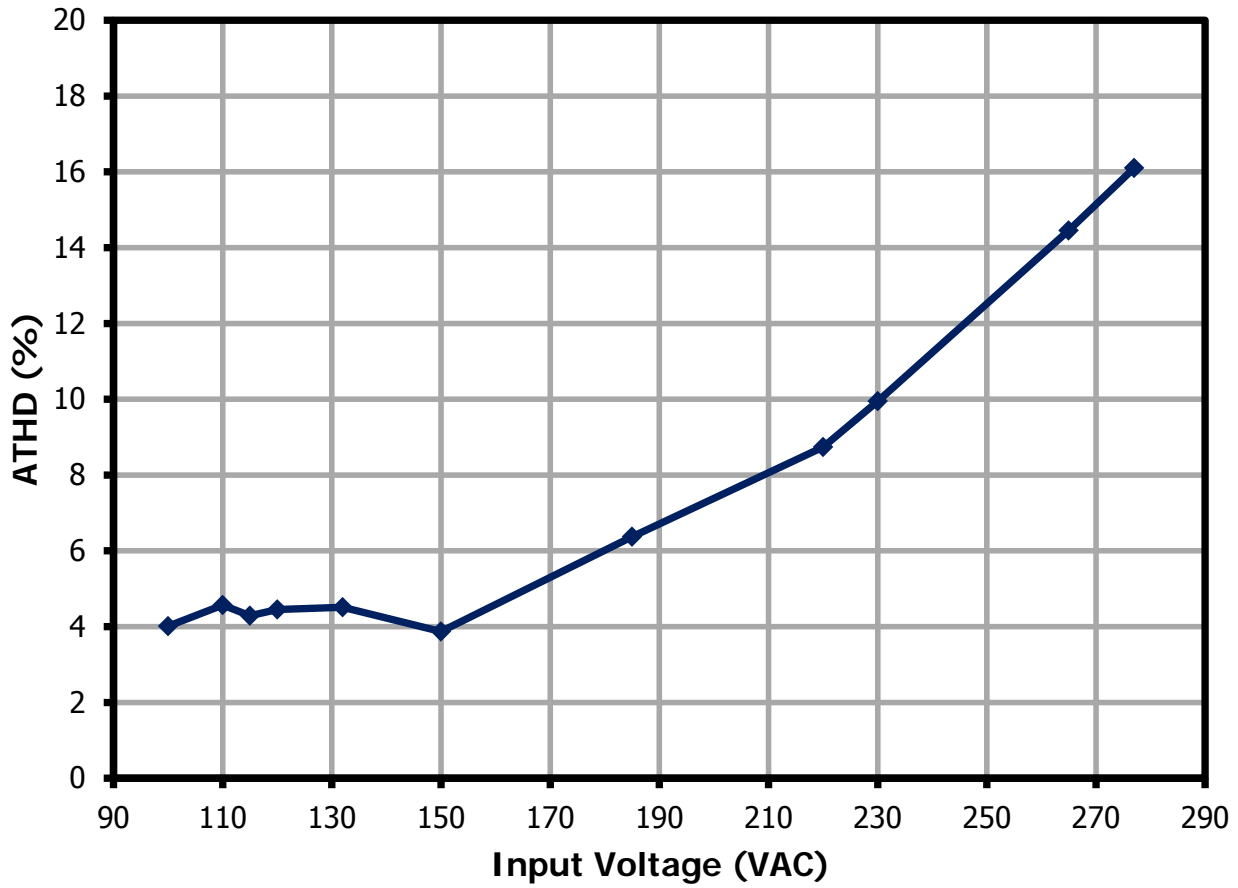

Figure 13 – %ATHD vs. Line.

9.6 Individual Harmonics Content

9.6.1 115 VAC, 60 Hz

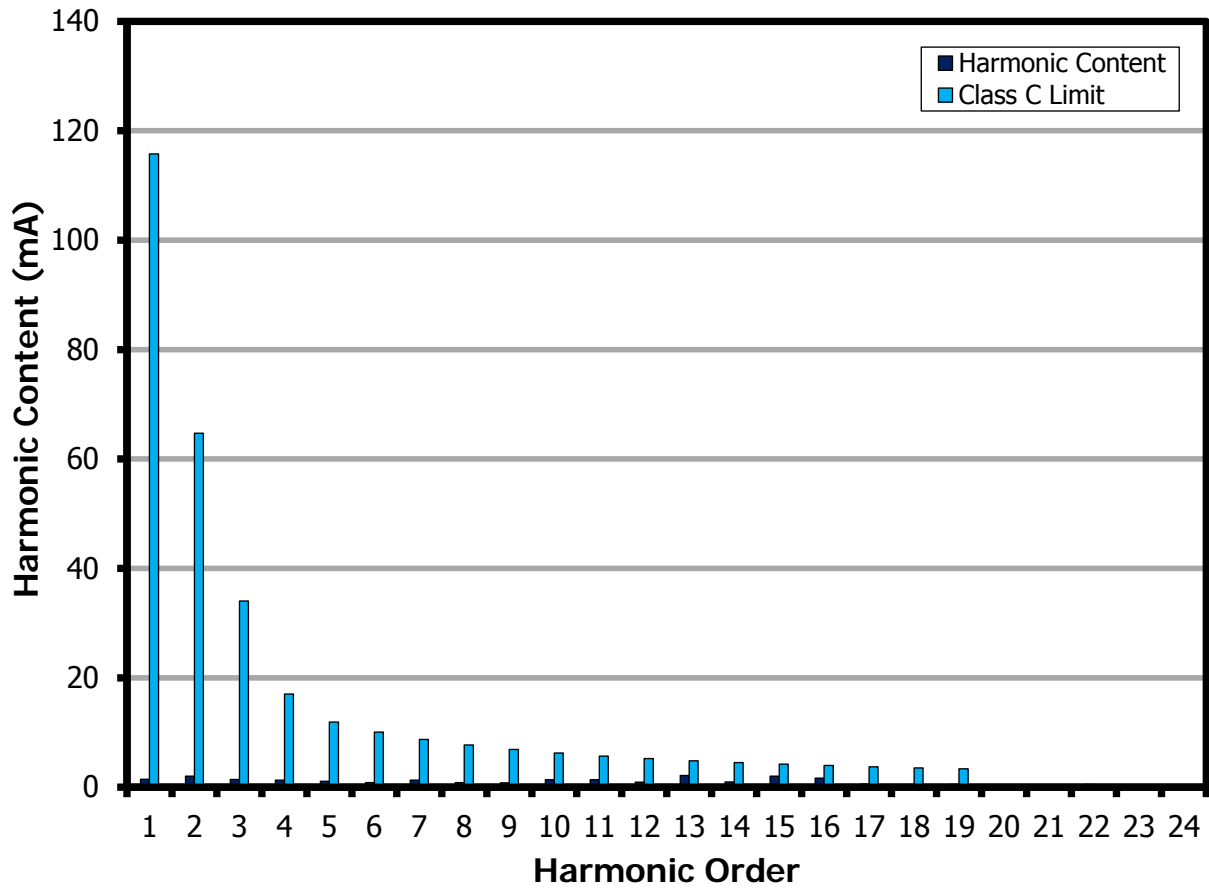

Figure 14 – 80 V LED Load Input Current Harmonics at 115 VAC, 60 Hz.



9.6.2 230 VAC, 50 Hz

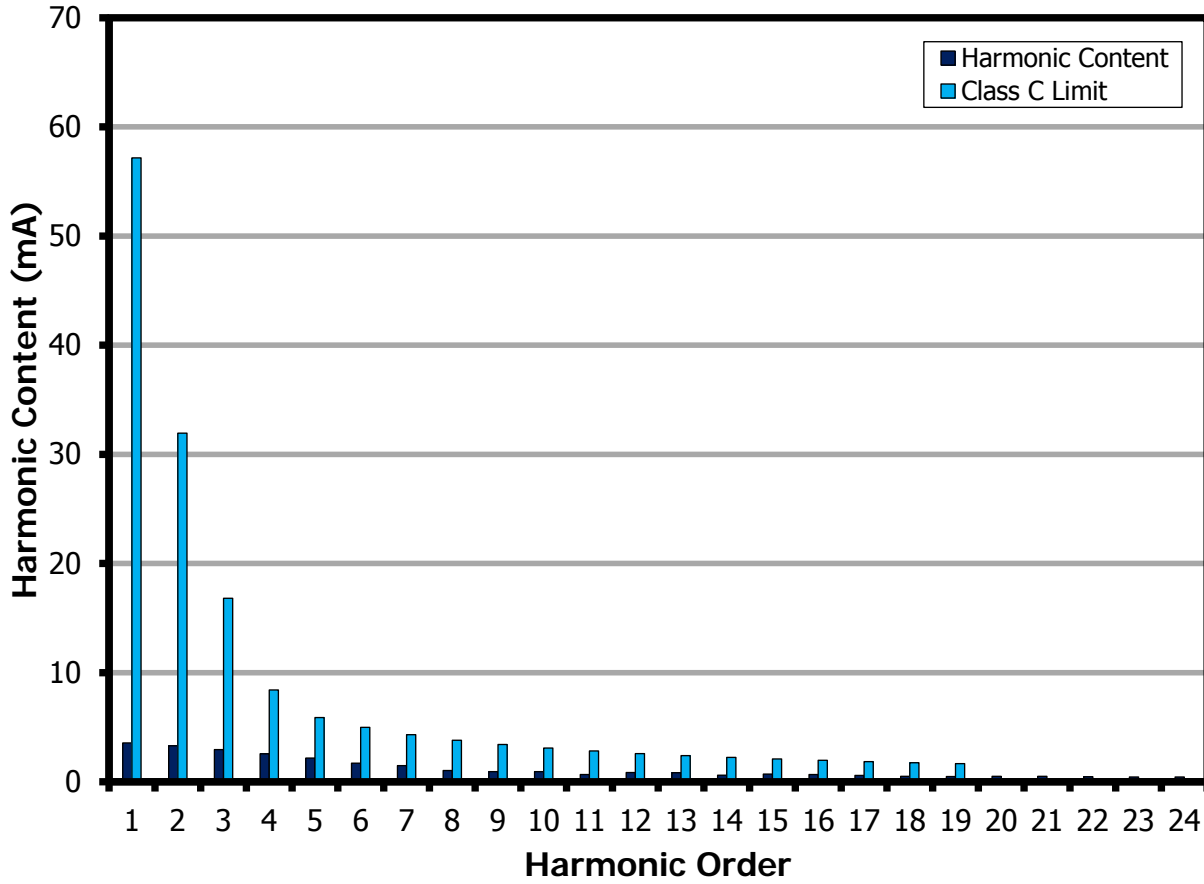

Figure 15 – 80 V LED Load Input Current Harmonics at 230 VAC, 50 Hz.

10 Test Data

10.1 Test Data, 80 V LED Load

Input		Input Measurement					LED Load Measurement			Efficiency (%)
VAC (V _{RMS})	Freq (Hz)	V _{IN} (V _{RMS})	I _{IN} (mA _{RMS})	P _{IN} (W)	PF	%ATHD	V _{OUT} (V _{DC})	I _{OUT} (mA _{DC})	P _{OUT} (W)	
100	60	100.0	173.0	17.13	0.99	4.01	79.3	186.9	14.9	86.98
110	60	110.0	157.8	17.16	0.99	4.57	79.3	188.3	15.0	87.49
115	60	115.0	149.9	17.03	0.99	4.29	79.3	187.9	15.0	87.98
120	60	120.0	142.3	16.84	0.99	4.45	79.2	186.3	14.8	88.15
132	60	132.0	130.1	16.89	0.98	4.51	79.2	187.7	15.0	88.60
150	50	150.0	115.0	16.91	0.98	3.87	79.2	188.9	15.1	89.22
185	50	195.0	89.1	16.75	0.96	6.37	79.2	187.7	15.0	89.40
220	50	220.0	80.7	16.88	0.95	8.74	79.2	189.3	15.1	89.43
230	50	230.1	77.3	16.81	0.95	9.95	79.2	188.6	15.0	89.45
265	50	265.0	68.9	16.86	0.92	14.45	79.2	189.0	15.1	89.40
277	50	277.1	66.6	16.88	0.91	16.10	79.2	189.1	15.1	89.36

10.2 Test Data, Harmonic Content at 115 VAC, 80 V LED Load

V	Freq	I (mA)	P	PF	%THD
115	60.00	149.93	17.0260	0.9875	4.29
nth Order	mA Content	% Content	Limit <25 W	Limit >25 W	Remarks
1	140.79				
2	0.09	0.06%		2.00%	
3	1.46	1.04%	115.78	29.63%	Pass
5	2.04	1.45%	64.70	10.00%	Pass
7	1.43	1.02%	34.05	7.00%	Pass
9	1.30	0.92%	17.03	5.00%	Pass
11	1.09	0.77%	11.92	3.00%	Pass
13	0.86	0.61%	10.08	3.00%	Pass
15	1.29	0.92%	8.74	3.00%	Pass
17	0.84	0.60%	7.71	3.00%	Pass
19	0.79	0.56%	6.90	3.00%	Pass
21	1.38	0.98%	6.24	3.00%	Pass
23	1.38	0.98%	5.70	3.00%	Pass
25	0.92	0.65%	5.24	3.00%	Pass
27	2.17	1.54%	4.86	3.00%	Pass
29	0.98	0.70%	4.52	3.00%	Pass
31	2.04	1.45%	4.23	3.00%	Pass
33	1.68	1.19%	115.78	3.00%	Pass
35	0.57	0.40%	64.70	3.00%	Pass
37	0.50	0.36%	34.05	3.00%	Pass
39	0.53	0.38%	17.03	3.00%	Pass

41	0.23	0.16%			
43	0.34	0.24%			
45	0.51	0.36%			
47	0.15	0.11%			
49	0.31	0.22%			

10.3 Test Data, Harmonic Content at 230 VAC, 80 V LED Load

V	Freq	I (mA)	P	PF	%THD
230	50.00	77.30	16.8140	0.9454	9.95
nth Order	mA Content	% Content	Limit <25 W	Limit >25 W	Remarks
1	75.58				
2	0.08	0.11%		2.00%	
3	3.55	4.70%	57.17	28.36%	Pass
5	3.29	4.35%	31.95	10.00%	Pass
7	2.95	3.90%	16.81	7.00%	Pass
9	2.55	3.37%	8.41	5.00%	Pass
11	2.18	2.88%	5.88	3.00%	Pass
13	1.70	2.25%	4.98	3.00%	Pass
15	1.47	1.94%	4.32	3.00%	Pass
17	1.02	1.35%	3.81	3.00%	Pass
19	0.93	1.23%	3.41	3.00%	Pass
21	0.93	1.23%	3.08	3.00%	Pass
23	0.66	0.87%	2.81	3.00%	Pass
25	0.85	1.12%	2.59	3.00%	Pass
27	0.82	1.08%	2.40	3.00%	Pass
29	0.60	0.79%	2.23	3.00%	Pass
31	0.71	0.94%	2.09	3.00%	Pass
33	0.66	0.87%	1.96	3.00%	Pass
35	0.59	0.78%	1.85	3.00%	Pass
37	0.49	0.65%	1.75	3.00%	Pass
39	0.47	0.62%	1.66	3.00%	Pass
41	0.50	0.66%			
43	0.50	0.66%			
45	0.46	0.61%			
47	0.44	0.58%			
49	0.44	0.58%			

11 Thermal Performance

11.1 Thermal Performance Scan

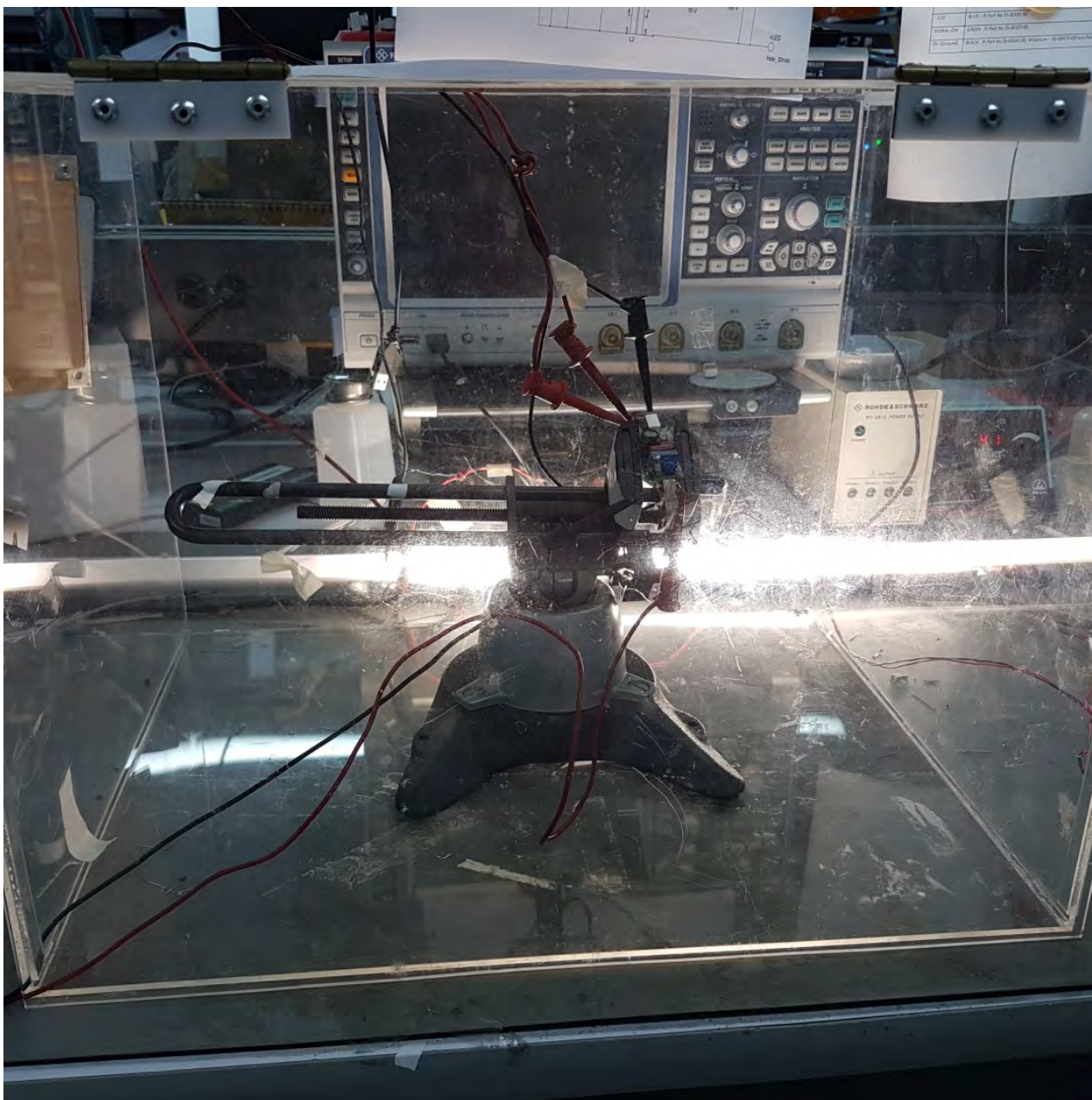

Figure 16 – Test Set-up.

Unit was placed inside an acrylic enclosure to prevent airflow that might affect the thermal measurements. Temperature was measured using FLIR thermal camera. The ambient temperature is 28 °C.

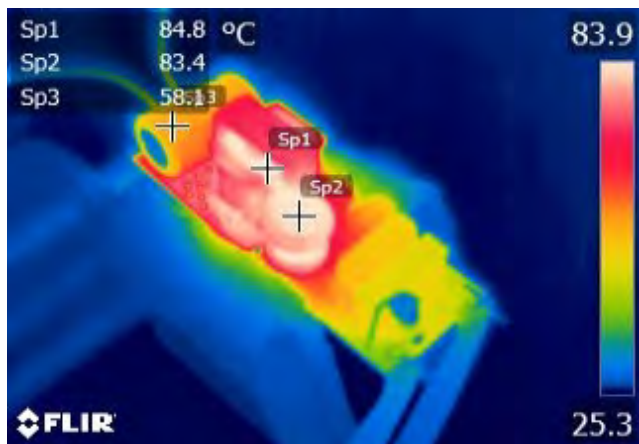

Figure 17 – 100 VAC, 80 V LED Load.
 Spot 1: Buck-Boost Inductor (L2): 84.8 °C.
 Spot 2: Input Inductor (L1): 83.4 °C.
 Spot 3: Output Capacitor (C8): 58.1 °C.

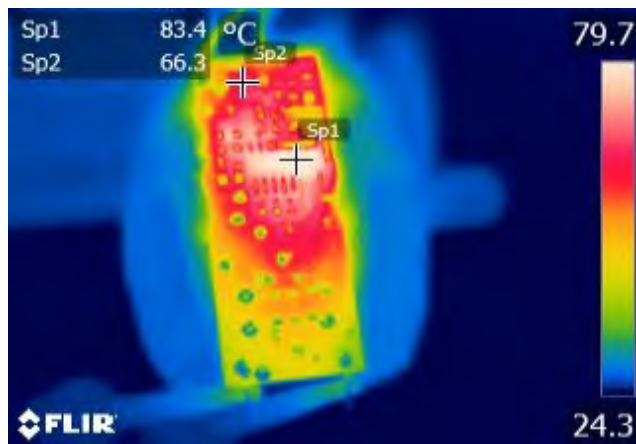

Figure 18 – 100 VAC, 80 V LED Load.
 Spot 1: LYTSwitch-5 (U1): 83.4 °C.
 Spot 2: Output Diode (D1): 66.3 °C.

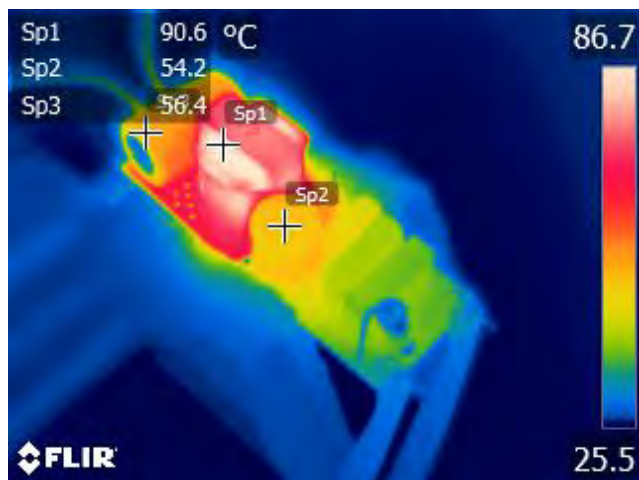

Figure 19 – 277 VAC, 80 V LED Load.
 Spot 1: Buck-Boost Inductor (L2): 90.6 °C.
 Spot 2: Input Inductor (L1): 54.2 °C.
 Spot 3: Output Capacitor (C8): 56.4 °C

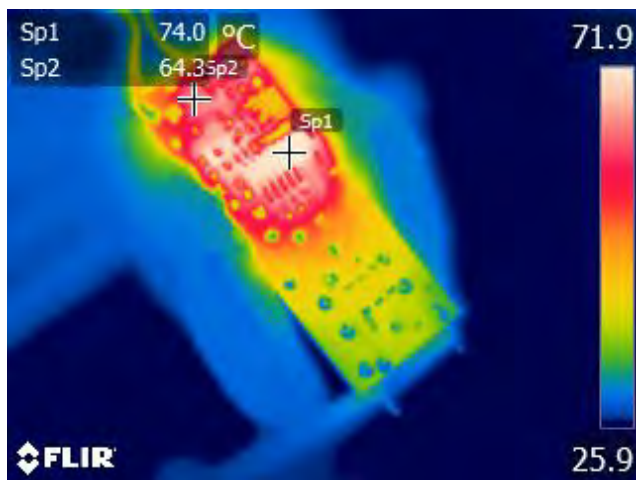

Figure 20 – 277 VAC, 80 V LED Load.
 Spot 1: LYTSwitch-5 (U1): 83.4 °C.
 Spot 2: Output Diode (D1): 66.3 °C.

12 Waveforms

12.1 Input Voltage and Input Current Waveforms

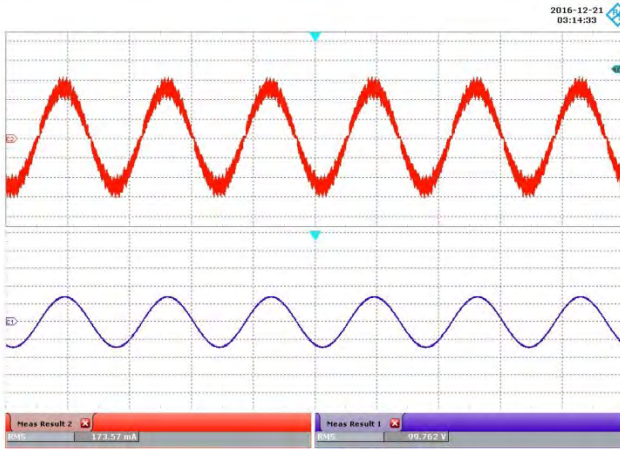

Figure 21 – 100 VAC, 80 V LED Load.
 Upper: I_{IN} , 100 mA / div.
 Lower: V_{IN} , 100 V / div., 10 ms / div.

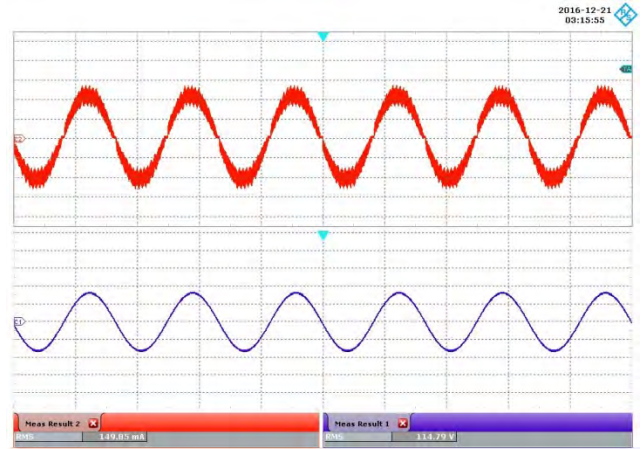

Figure 22 – 115 VAC, 80 V LED Load.
 Upper: I_{IN} , 100 mA / div.
 Lower: V_{IN} , 100 V / div., 10 ms / div.

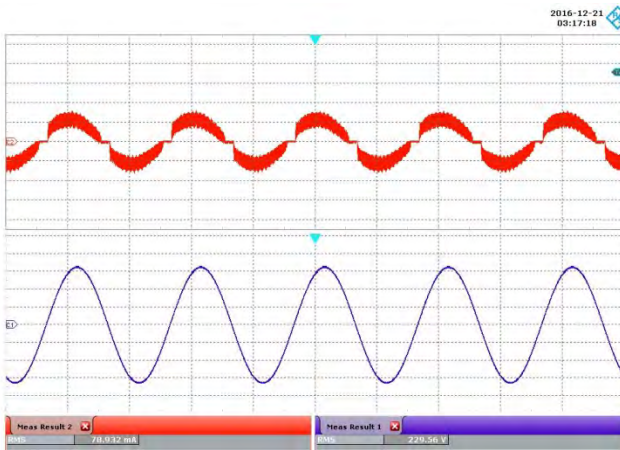

Figure 23 – 230 VAC, 80 V LED Load.
 Upper: I_{IN} , 100 mA / div.
 Lower: V_{IN} , 100 V / div., 10 ms / div.

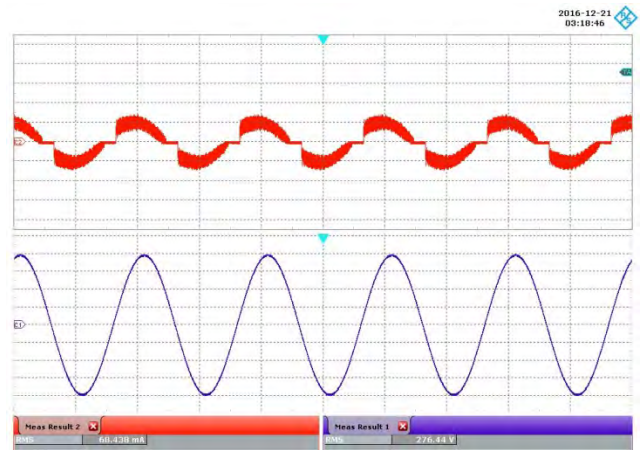

Figure 24 – 277 VAC, 80 V LED Load.
 Upper: I_{IN} , 100 mA / div.
 Lower: V_{IN} , 100 V / div., 10 ms / div.

12.2 Input Voltage and Input Current Waveforms – Electronic Ballast

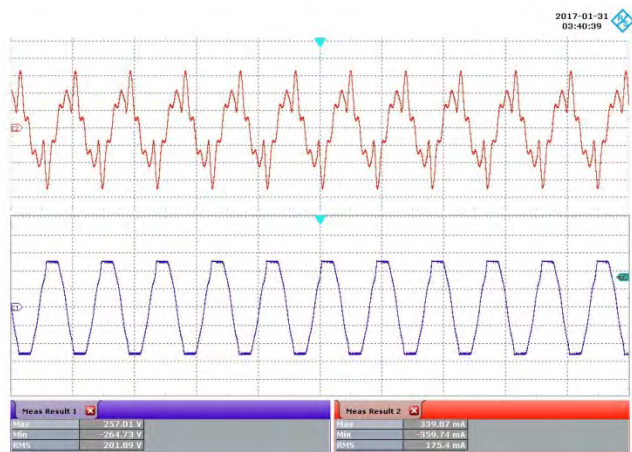

Figure 25 – 100 VAC, 80 V LED Load.
 Upper: I_{IN} , 100 mA / div.
 Lower: V_{IN} , 100 V / div., 20 us / div.

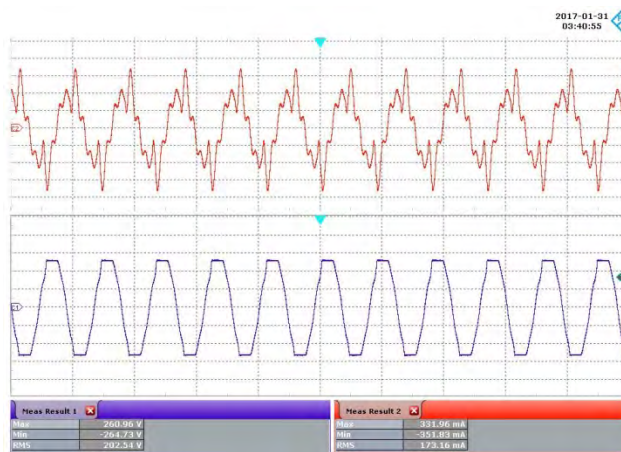

Figure 26 – 115 VAC, 80 V LED Load.
 Upper: I_{IN} , 100 mA / div.
 Lower: V_{IN} , 100 V / div., 20 us / div.

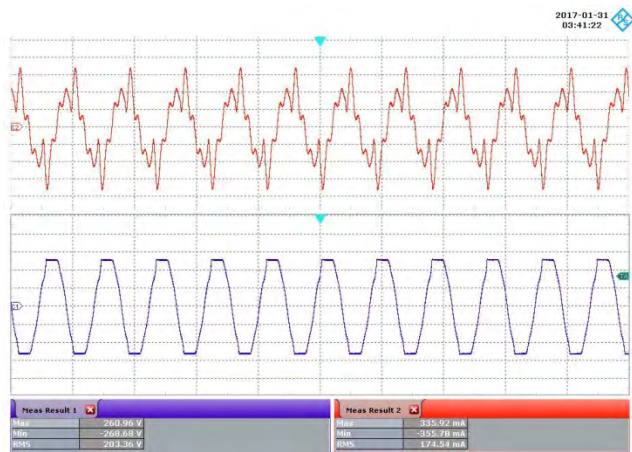

Figure 27 – 230 VAC, 80 V LED Load.
 Upper: I_{IN} , 100 mA / div.
 Lower: V_{IN} , 100 V / div., 20 us / div.

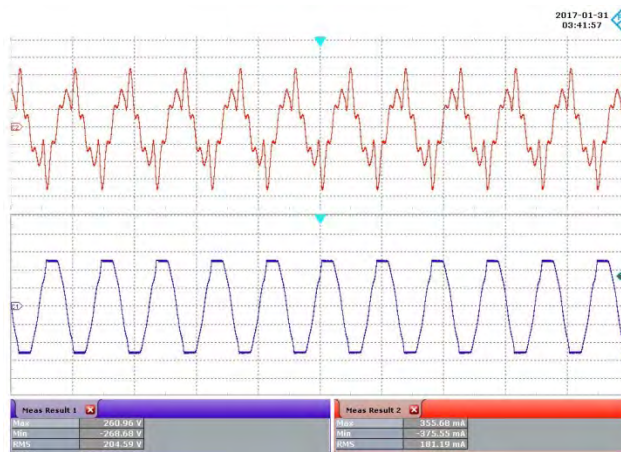

Figure 28 – 277 VAC, 80 V LED Load.
 Upper: I_{IN} , 100 mA / div.
 Lower: V_{IN} , 100 V / div., 20 us / div.

12.3 Input Voltage and Input Current Waveforms – Magnetic Ballast

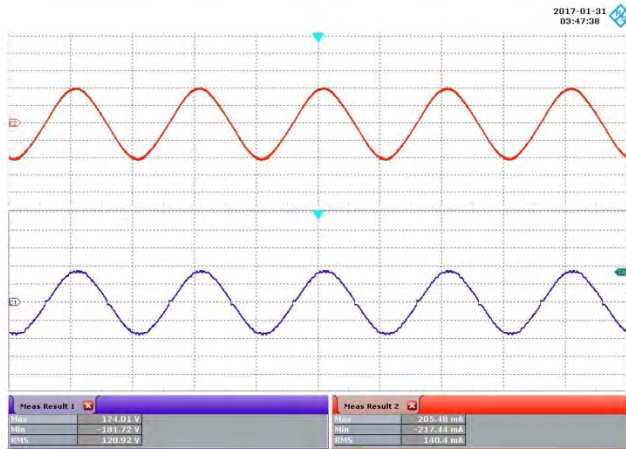

Figure 29 – 150 VAC, 80 V LED Load.
Upper: I_{IN} , 100 mA / div.
Lower: V_{IN} , 100 V / div., 10 ms / div.

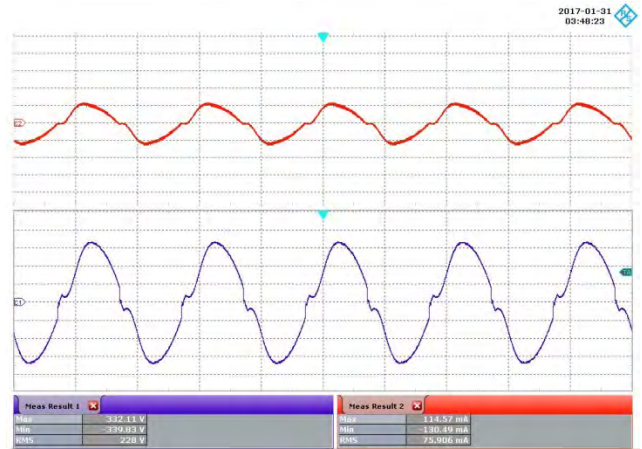

Figure 30 – 230 VAC, 80 V LED Load.
Upper: I_{IN} , 100 mA / div.
Lower: V_{IN} , 100 V / div., 10 ms / div.

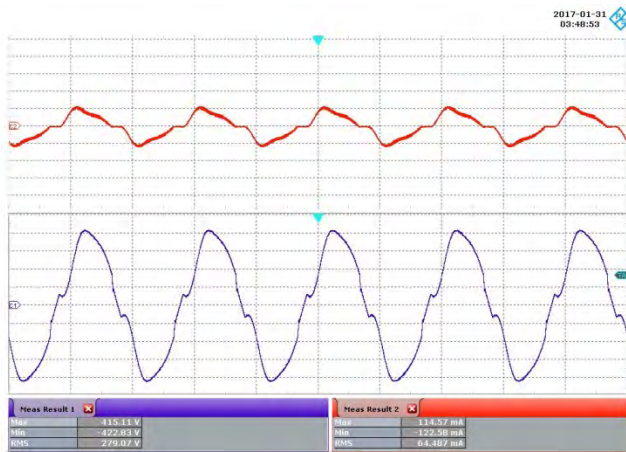

Figure 31 – 277 VAC, 80 V LED Load.
Upper: I_{IN} , 100 mA / div.
Lower: V_{IN} , 100 V / div., 10 ms / div.

12.4 Start-up Profile

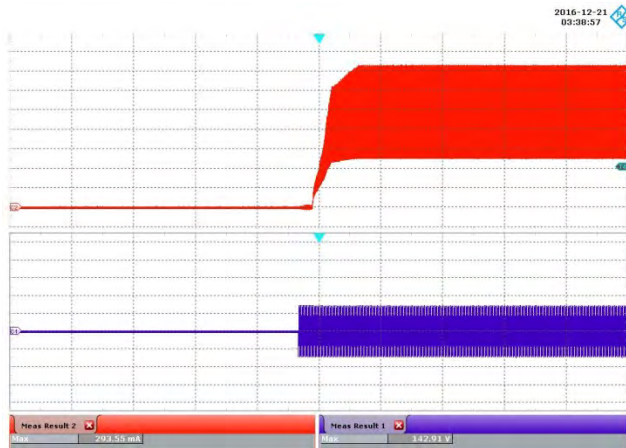

Figure 32 – 100 VAC, 80 V LED, Output Rise.
 Upper: I_{OUT} , 40 mA / div.
 Lower: V_{IN} , 100 V / div., 1 s / div.

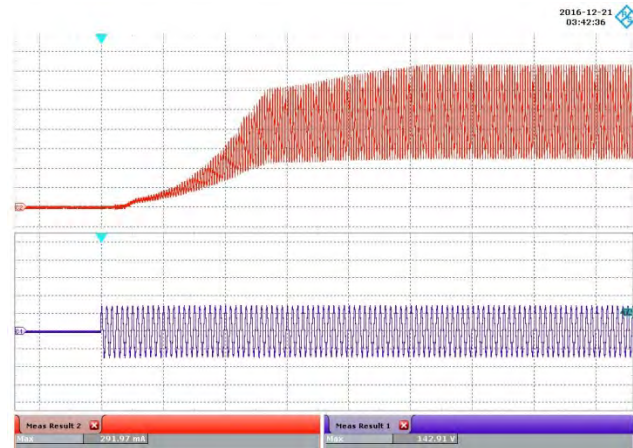

Figure 33 – 100 VAC, 80 V LED, Output Rise.
 Upper: I_{OUT} , 40 mA / div.
 Lower: V_{IN} , 100 V / div., 200 ms / div.

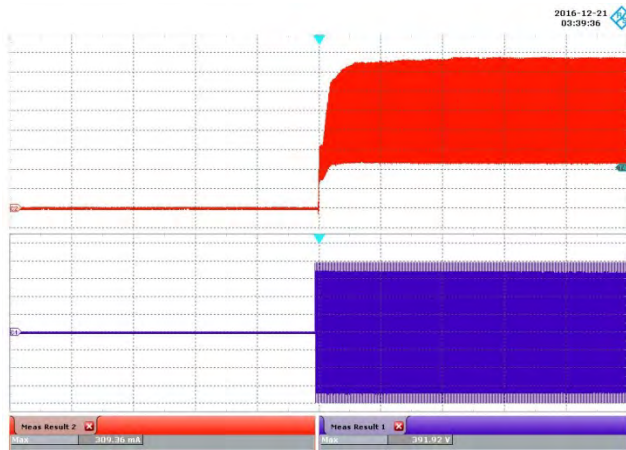

Figure 34 – 277 VAC, 80 V LED, Output Rise.
 Upper: I_{OUT} , 40 mA / div.
 Lower: V_{IN} , 50 V / div., 1 s / div.

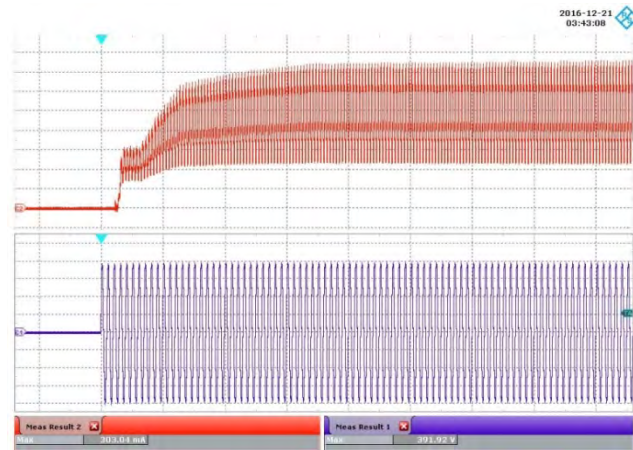

Figure 35 – 277 VAC, 80 V LED, Output Rise.
 Upper: I_{OUT} , 40 mA / div.
 Lower: V_{IN} , 50 V / div., 200 ms / div.

12.5 Output Current Fall

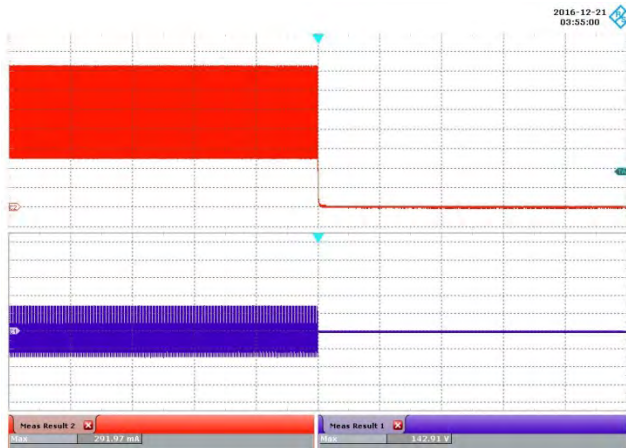

Figure 36 – 100 VAC, 80 V LED, Output Fall.
 Upper: I_{OUT} , 40 mA / div.
 Lower: V_{IN} , 50 V / div., 1 s / div.

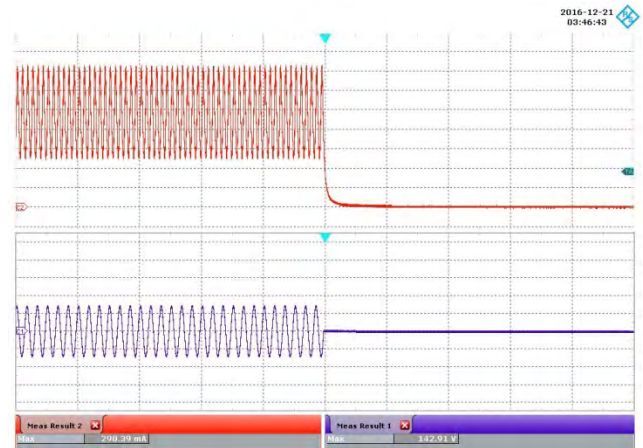

Figure 37 – 100 VAC, 80 V LED, Output Fall.
 Upper: I_{OUT} , 40 mA / div.
 Lower: V_{IN} , 50 V / div., 100 ms / div.

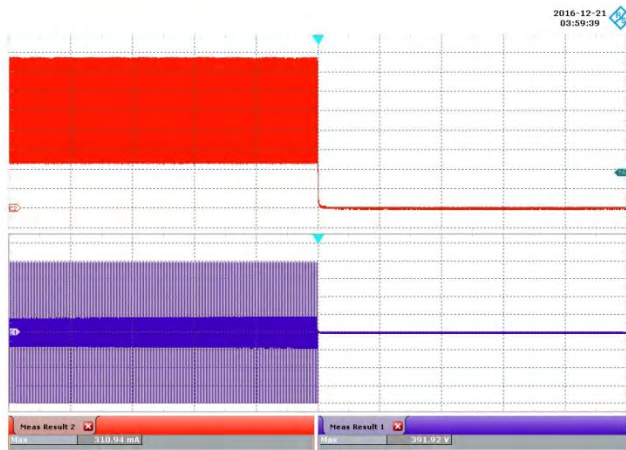

Figure 38 – 277 VAC, 80 V LED, Output Fall.
 Upper: I_{OUT} , 40 mA / div.
 Lower: V_{IN} , 50 V / div., 1 s / div.

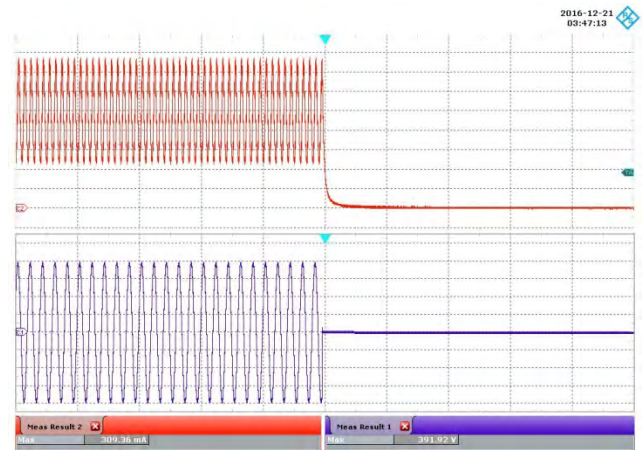

Figure 39 – 277 VAC, 80 V LED, Output Fall.
 Upper: I_{OUT} , 40 mA / div.
 Lower: V_{IN} , 50 V / div., 100 ms / div.

12.6 Drain Voltage and Current in Normal Operation

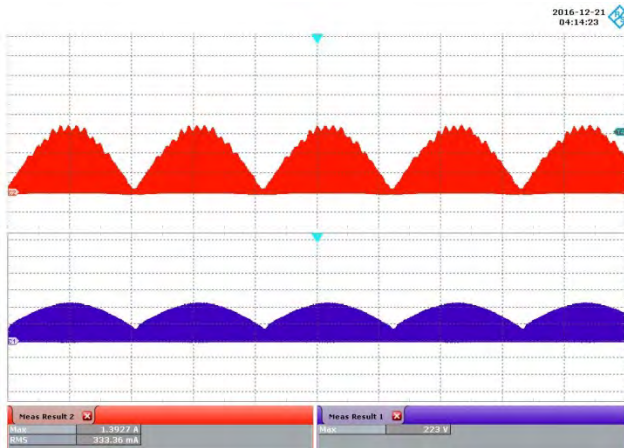

Figure 40 – 100 VAC, 80 V LED Load.
 Upper: I_{DRAIN} , 400 mA / div.
 Lower: V_{DRAIN} , 100V / div., 4 ms / div.



Figure 41 – 100 VAC, 80 V LED Load.
 Upper: I_{DRAIN} , 400 mA / div.
 Lower: V_{DRAIN} , 100 V / div., 5 μ s / div.

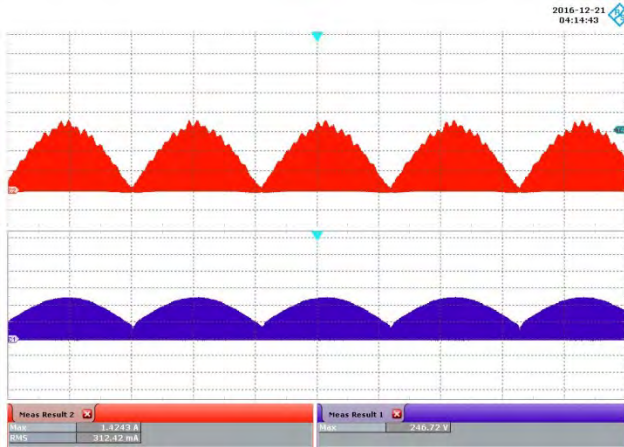

Figure 42 – 115 VAC, 80 V LED Load.
 Upper: I_{DRAIN} , 400 mA / div.
 Lower: V_{DRAIN} , 100 V / div., 4 ms / div.



Figure 43 – 115 VAC, 80 V LED Load.
 Upper: I_{DRAIN} , 400 mA / div.
 Lower: V_{DRAIN} , 100 V / div., 5 μ s / div.

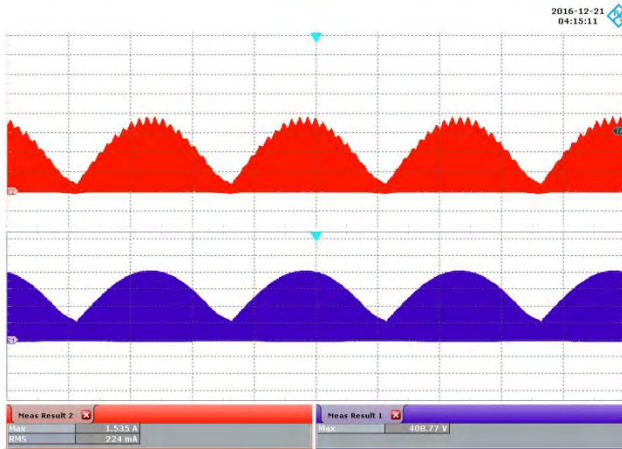

Figure 44 – 230 VAC, 80 V LED Load.
 Upper: I_{DRAIN} , 400 mA / div.
 Lower: V_{DRAIN} , 100 V / div., 4 ms / div.

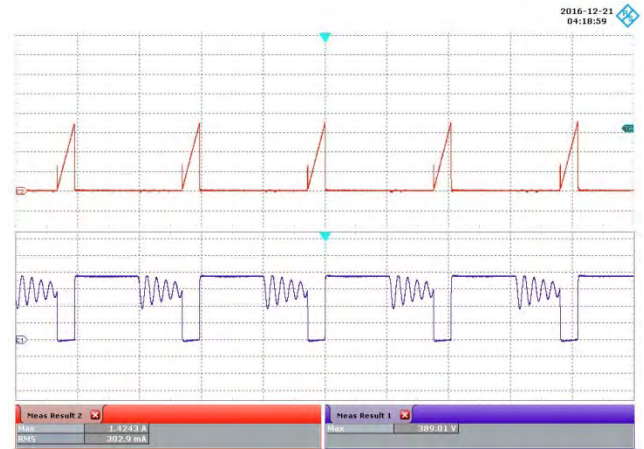

Figure 45 – 230 VAC, 80 V LED Load.
 Upper: I_{DRAIN} , 400 mA / div.
 Lower: V_{DRAIN} , 100 V / div., 5 μ s / div.

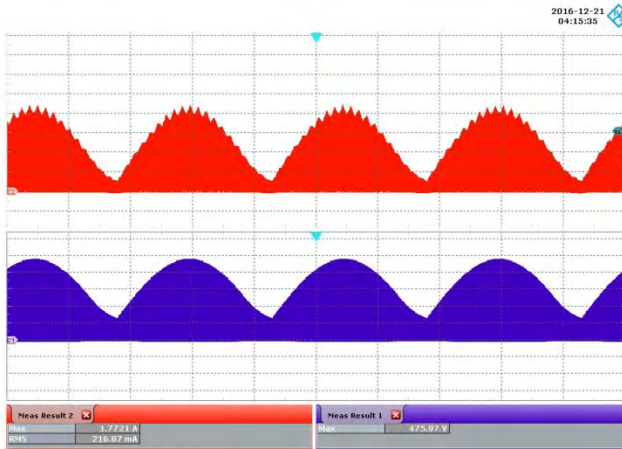

Figure 46 – 277 VAC, 80 V LED Load.
 Upper: I_{DRAIN} , 400 mA / div.
 Lower: V_{DRAIN} , 100 V / div., 4 ms / div.



Figure 47 – 277 VAC, 80 V LED Load.
 Upper: I_{DRAIN} , 400 mA / div.
 Lower: V_{DRAIN} , 100 V / div., 5 μ s / div.

12.7 Drain Voltage and Current Start-up Profile

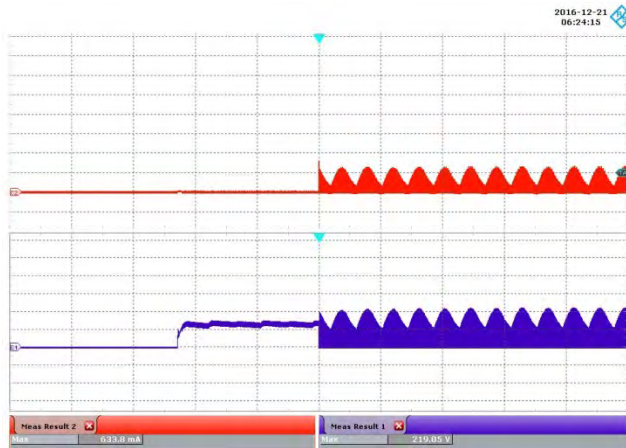

Figure 48 – 100 VAC, 80 V LED Load.
 Upper: I_{DRAIN} , 400 mA / div.
 Lower: V_{DRAIN} , 100 V / div., 20 ms / div.

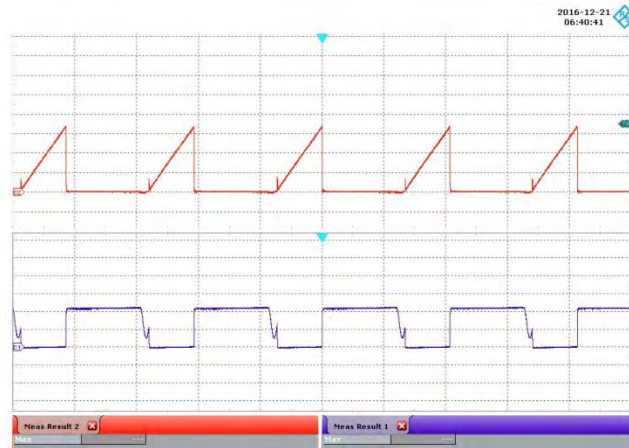

Figure 49 – 100 VAC, 80 V LED Load.
 Upper: I_{DRAIN} , 400 mA / div.
 Lower: V_{DRAIN} , 100 V / div., 4 μs / div.

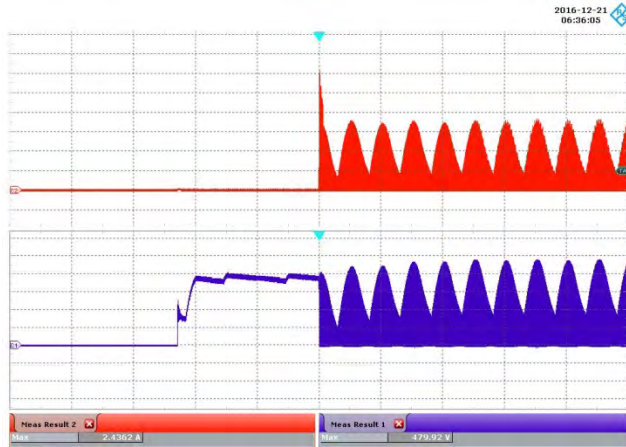

Figure 50 – 277 VAC, 80 V LED Load.
 Upper: I_{DRAIN} , 400 mA / div.
 Lower: V_{DRAIN} , 100 V / div., 20 ms / div.

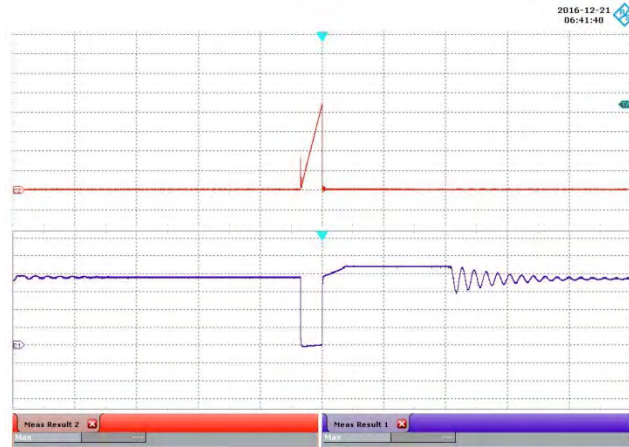

Figure 51 – 277 VAC, 80 V LED Load.
 Upper: I_{DRAIN} , 400 mA / div.
 Lower: V_{DRAIN} , 100 V / div., 4 μs / div.

12.8 Drain Voltage and Current During Output Short-Circuit

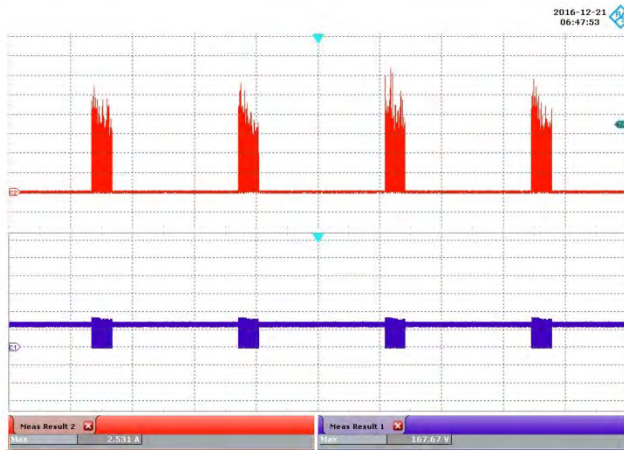

Figure 52 – 100 VAC, Output Short-Circuit.
 Upper: I_{DRAIN} , 400 mA / div.
 Lower: V_{DRAIN} , 100 V / div., 1 s / div.

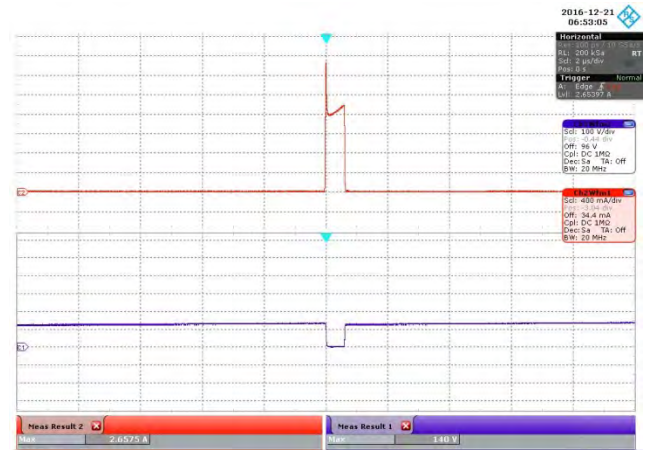

Figure 53 – 100 VAC, Output Short-Circuit.
 Upper: I_{DRAIN} , 400 mA / div.
 Lower: V_{DRAIN} , 100 V / div., 2 μ s / div.

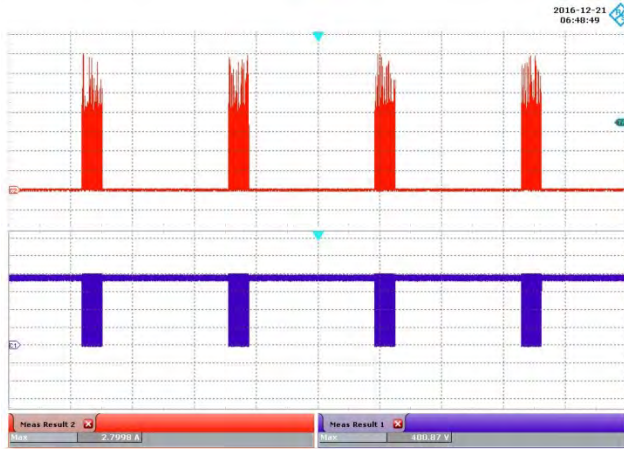

Figure 54 – 277 VAC, Output Short-Circuit.
 Upper: I_{DRAIN} , 400 mA / div.
 Lower: V_{DRAIN} , 100 V / div., 1 s / div.

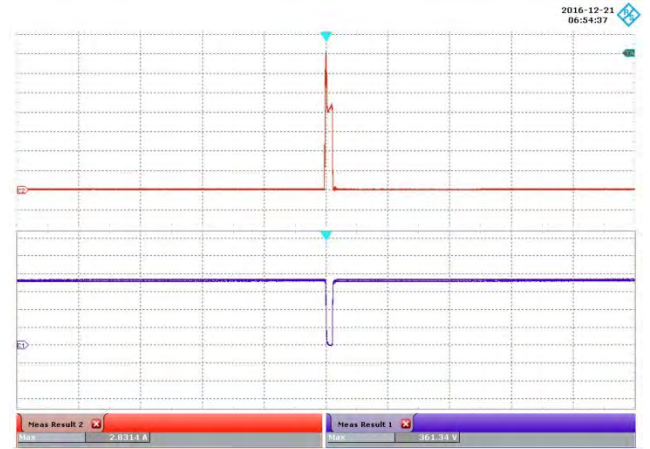

Figure 55 – 277 VAC, Output Short-Circuit.
 Upper: I_{DRAIN} , 400 mA / div.
 Lower: V_{DRAIN} , 100 V / div., 2 μ s / div.



12.9 Output Diode Voltage and Current in Normal Operation

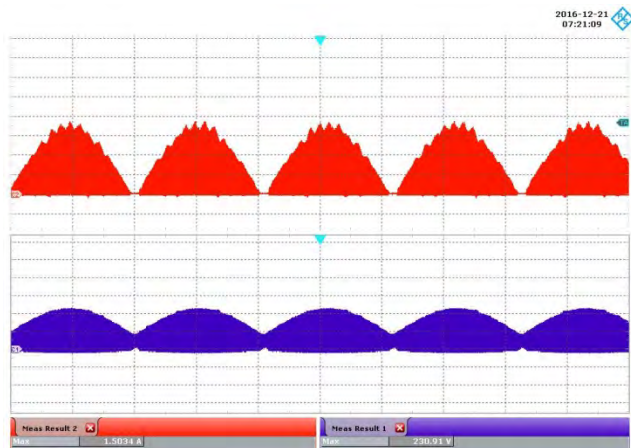

Figure 56 – 100 VAC, 80 V LED Load.
 Upper: I_{D1} , 400 mA / div.
 Lower: V_{D1} , 100 V / div., 4 ms / div.

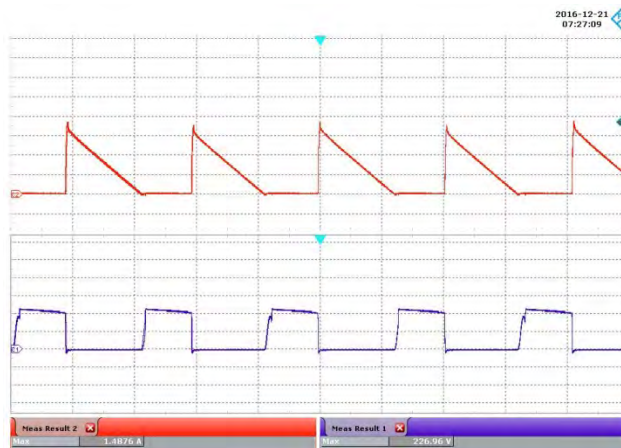

Figure 57 – 100 VAC, 80 V LED Load.
 Upper: I_{D1} , 400 mA / div.
 Lower: V_{D1} , 100 V / div., 4 μ s / div.

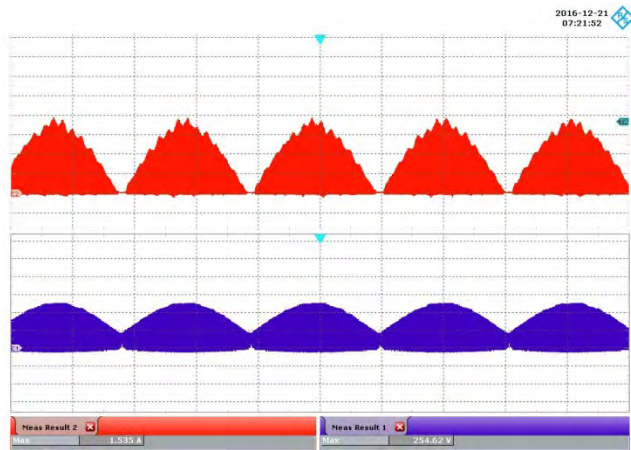

Figure 58 – 115 VAC, 80 V LED Load.
 Upper: I_{D1} , 400 mA / div.
 Lower: V_{D1} , 100 V / div., 4 ms / div.



Figure 59 – 115 VAC, 80 V LED Load.
 Upper: I_{D1} , 400 mA / div.
 Lower: V_{D1} , 100 V / div., 4 μ s / div.

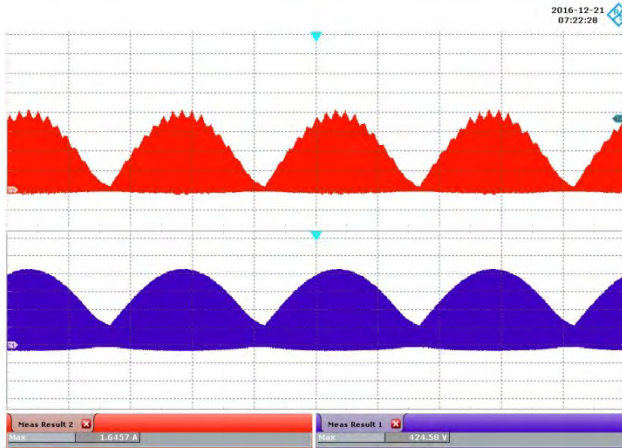

Figure 60 – 230 VAC, 80 V LED Load.
 Upper: I_{D1} , 400 mA / div.
 Lower: V_{D1} , 100 V / div., 4 ms / div.

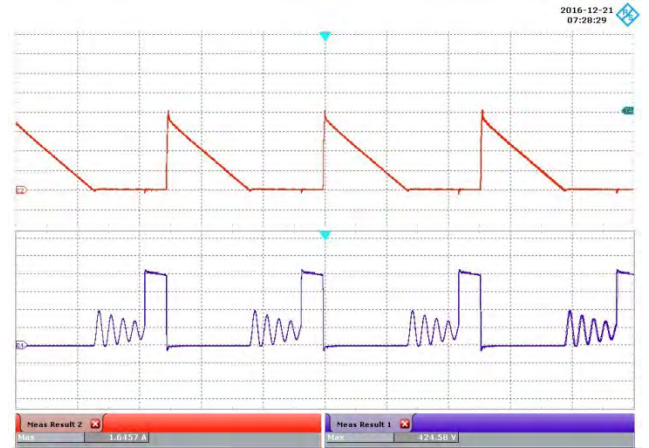

Figure 61 – 230 VAC, 80 V LED Load.
 Upper: I_{D1} , 400 mA / div.
 Lower: V_{D1} , 100 V / div., 4 μ s / div.

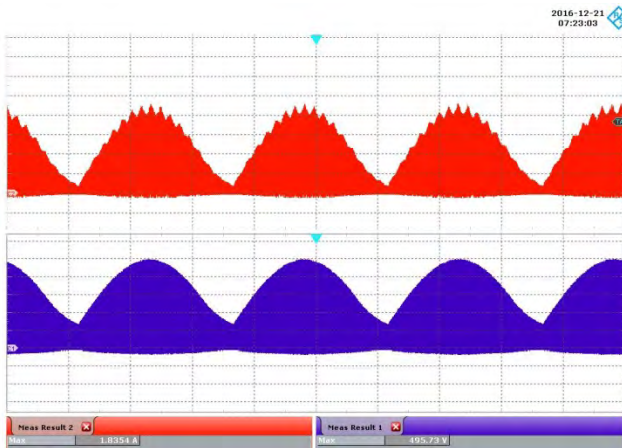

Figure 62 – 277 VAC, 80 V LED Load.
 Upper: I_{D1} , 400 mA / div.
 Lower: V_{D1} , 100 V / div., 4 ms / div.

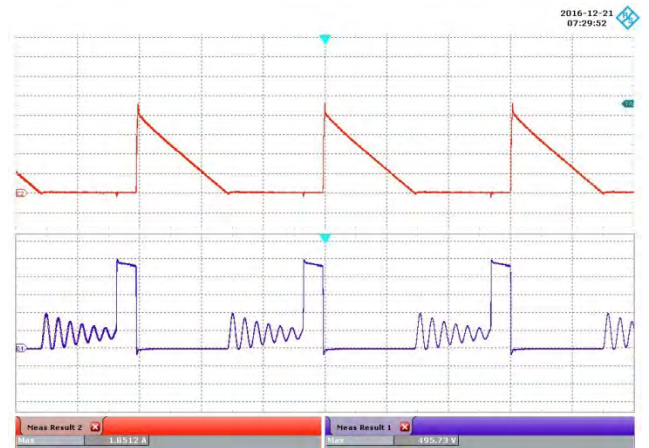

Figure 63 – 277 VAC, 80 V LED Load.
 Upper: I_{D1} , 400 mA / div.
 Lower: V_{D1} , 100 V / div., 4 μ s / div.

12.10 Output Voltage and Current – Open Output LED Load

Maximum measured no-load output voltage is below the surge voltage rating of the output capacitor.

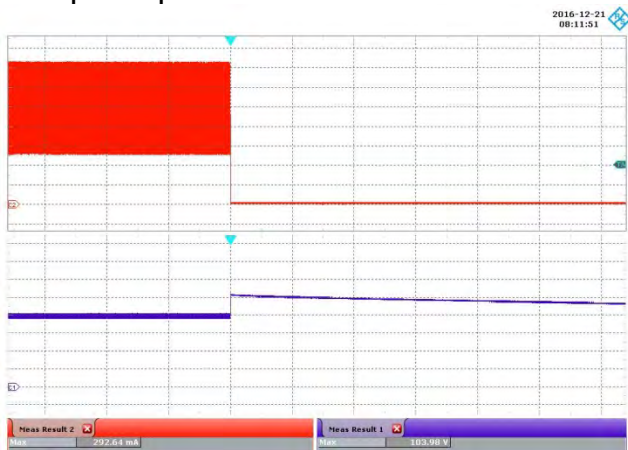

Figure 64 – 100 VAC, 80 V LED Load.
Running Open Load.
Upper: I_{OUT} , 40 mA / div.
Lower: V_{OUT} , 20 V / div., 2 s / div.

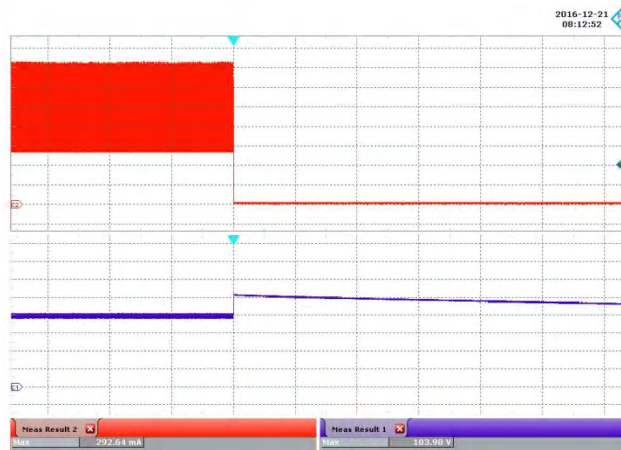

Figure 65 – 277 VAC, 80 V LED Load.
Running Open Load.
Upper: I_{OUT} , 40 mA / div.
Lower: V_{OUT} , 20 V / div., 2 s / div.

12.11 Output Voltage and Current – Start-up at Open Output Load

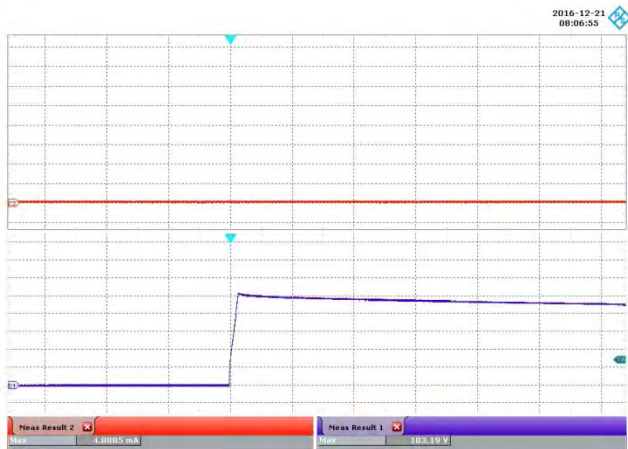

Figure 66 – 100 VAC, Open Load.
Open Load Start-up.
Upper: I_{OUT} , 40 mA / div.
Lower: V_{OUT} , 20 V / div., 2 s / div.

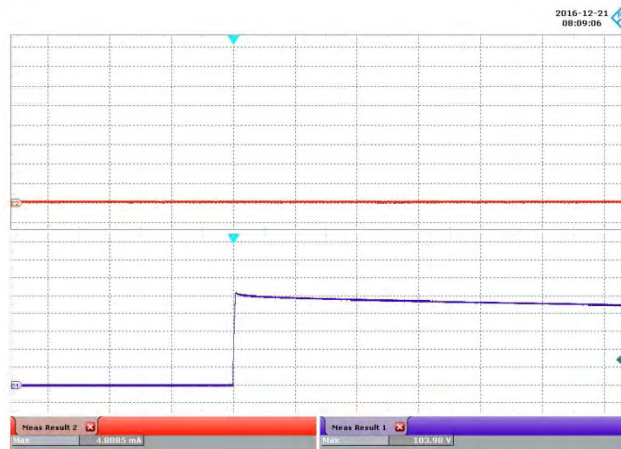

Figure 67 – 277 VAC, Open Load.
Open Load Start-up.
Upper: I_{OUT} , 40 mA / div.
Lower: V_{OUT} , 20 V / div., 2 s / div.

12.12 Output Ripple Current

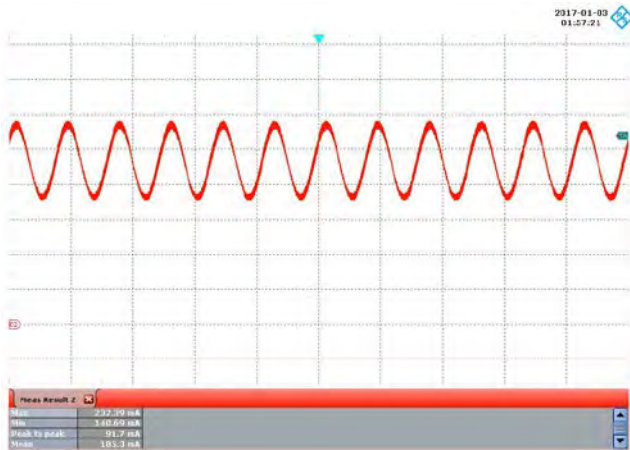

Figure 68 – 100 VAC, 60 Hz, 80 V LED Load.
Upper: I_{OUT} , 40 mA / div., 10 ms / div.

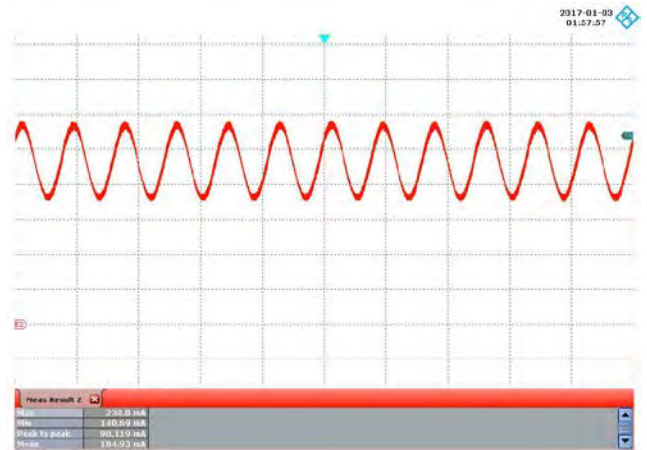

Figure 69 – 115 VAC, 60 Hz, 80 V LED Load.
Upper: I_{OUT} , 40 mA / div., 10 ms / div.

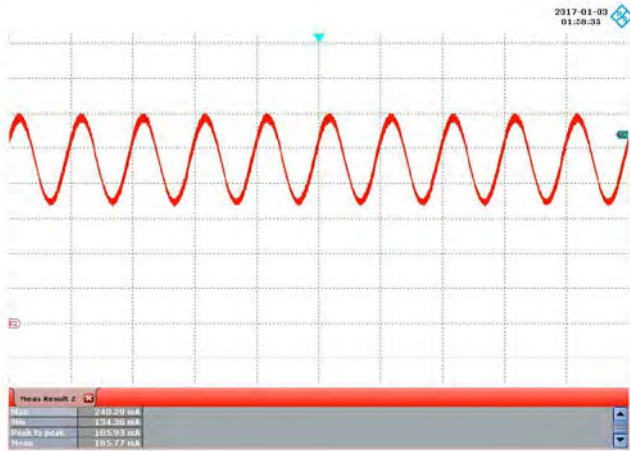

Figure 70 – 230 VAC, 50 Hz, 80 V LED Load.
Upper: I_{OUT} , 40 mA / div., 10 ms / div.

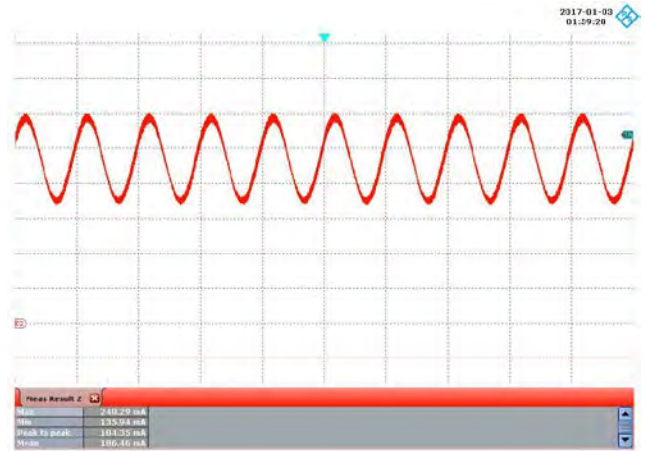

Figure 71 – 277 VAC, 50 Hz, 80 V LED Load.
Upper: I_{OUT} , 40 mA / div., 10 ms / div.

V_{IN} (VAC)	$I_{OUT(MAX)}$ (mA)	$I_{OUT(MIN)}$ (mA)	I_{MEAN} (mA)	Ripple Ratio (I_{RP-P} / I_{MEAN})	% Flicker $100 \times (I_{RP-P} / I_{OUT(MAX)} + I_{OUT(MIN)})$
100	0.232	0.141	0.185	0.49	24.40
115	0.231	0.141	0.185	0.49	24.19
230	0.240	0.134	0.186	0.57	28.34
277	0.240	0.136	0.186	0.56	27.66



13 AC Cycling Test

No output current overshoot was observed during on - off cycling.

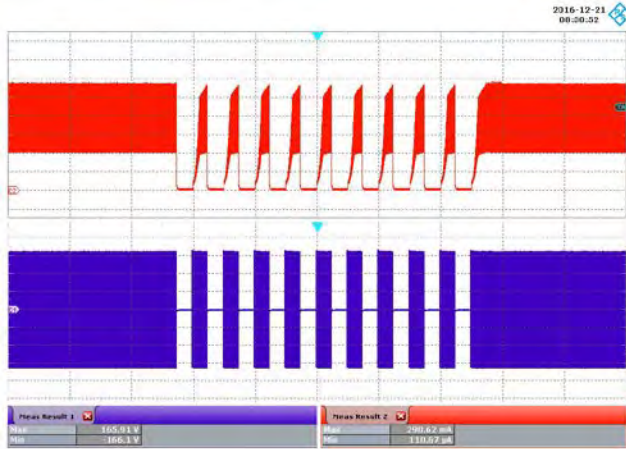

Figure 72 – 115 VAC, 80 V LED Load.
 1 s On – 1 s Off.
 Upper: I_{OUT} , 50 mA / div.
 Lower: V_{IN} , 50 V / div., 4 s / div.

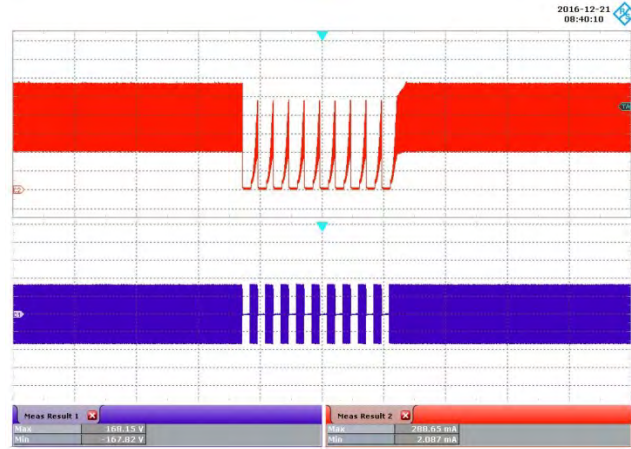

Figure 73 – 115 VAC, 80 V LED Load.
 0.5 s On – 0.5 s Off.
 Upper: I_{OUT} , 50 mA / div.
 Lower: V_{IN} , 50 V / div., 2 s / div.

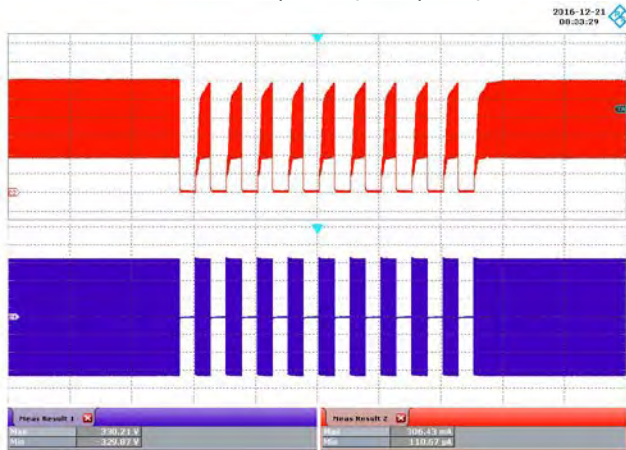

Figure 74 – 230 VAC, 80 V LED Load.
 1 s On – 1 s Off.
 Upper: I_{OUT} , 50 mA / div.
 Lower: V_{IN} , 50 V / div., 1 s / div.

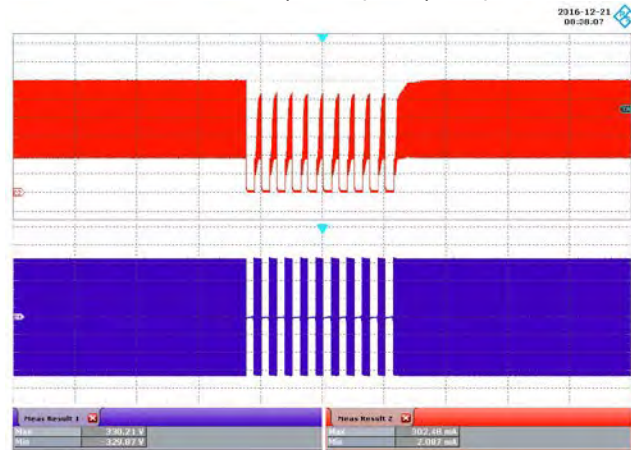

Figure 75 – 230 VAC, 80 V LED Load.
 0.5 s On – 0.5 s Off.
 Upper: I_{OUT} , 50 mA / div.
 Lower: V_{IN} , 50 V / div., 2 s / div.

14 Conducted EMI

14.1 Test Set-up

14.1.1 Equipment and Load Used

1. Rohde and Schwarz ENV216 two line V-network.
2. Rohde and Schwarz ESRP EMI test receiver.
3. Hioki 3322 power hitester.
4. Chroma measurement test fixture.
5. 80 V LED load with input voltage set at 115/230VAC.

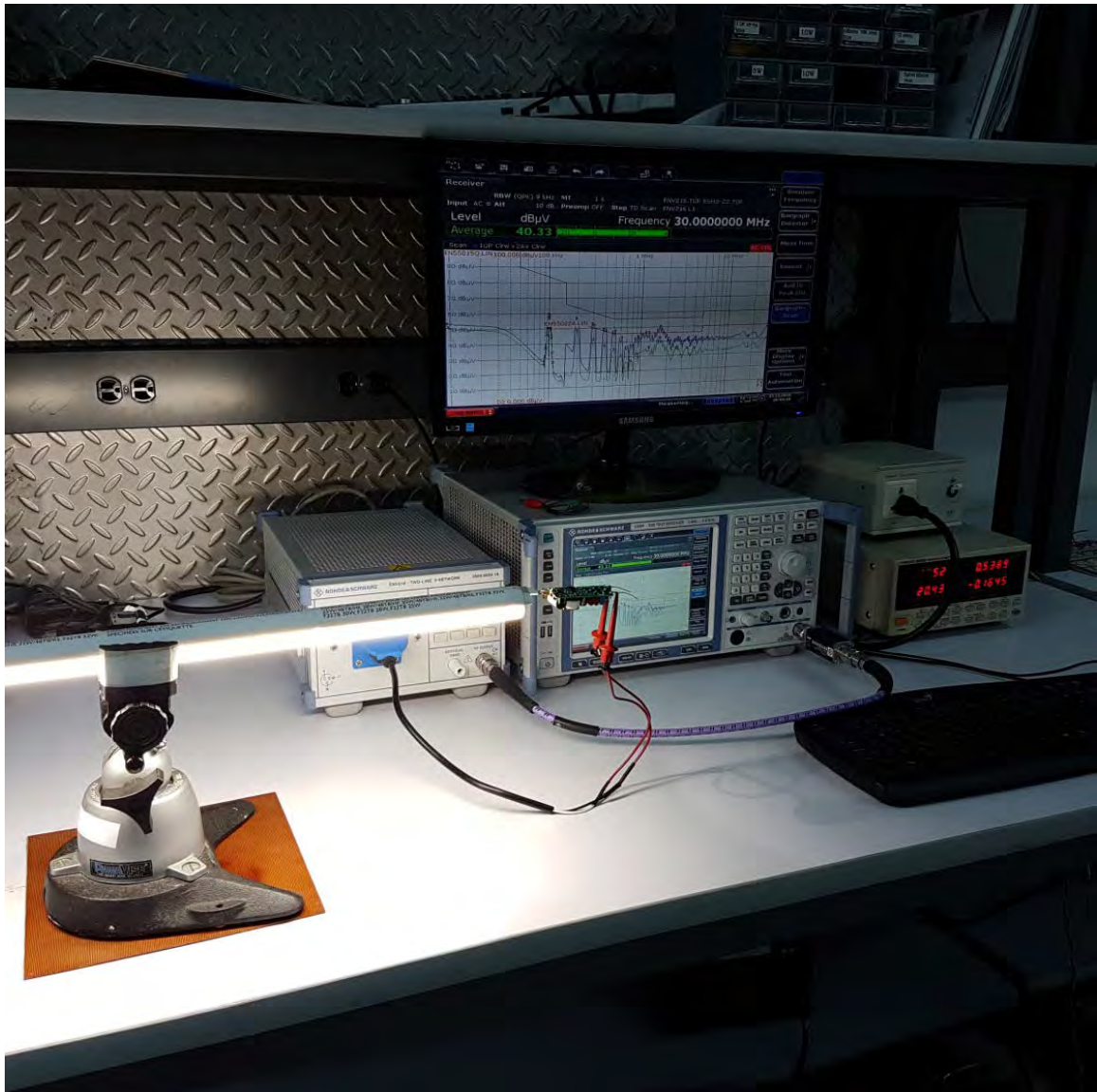
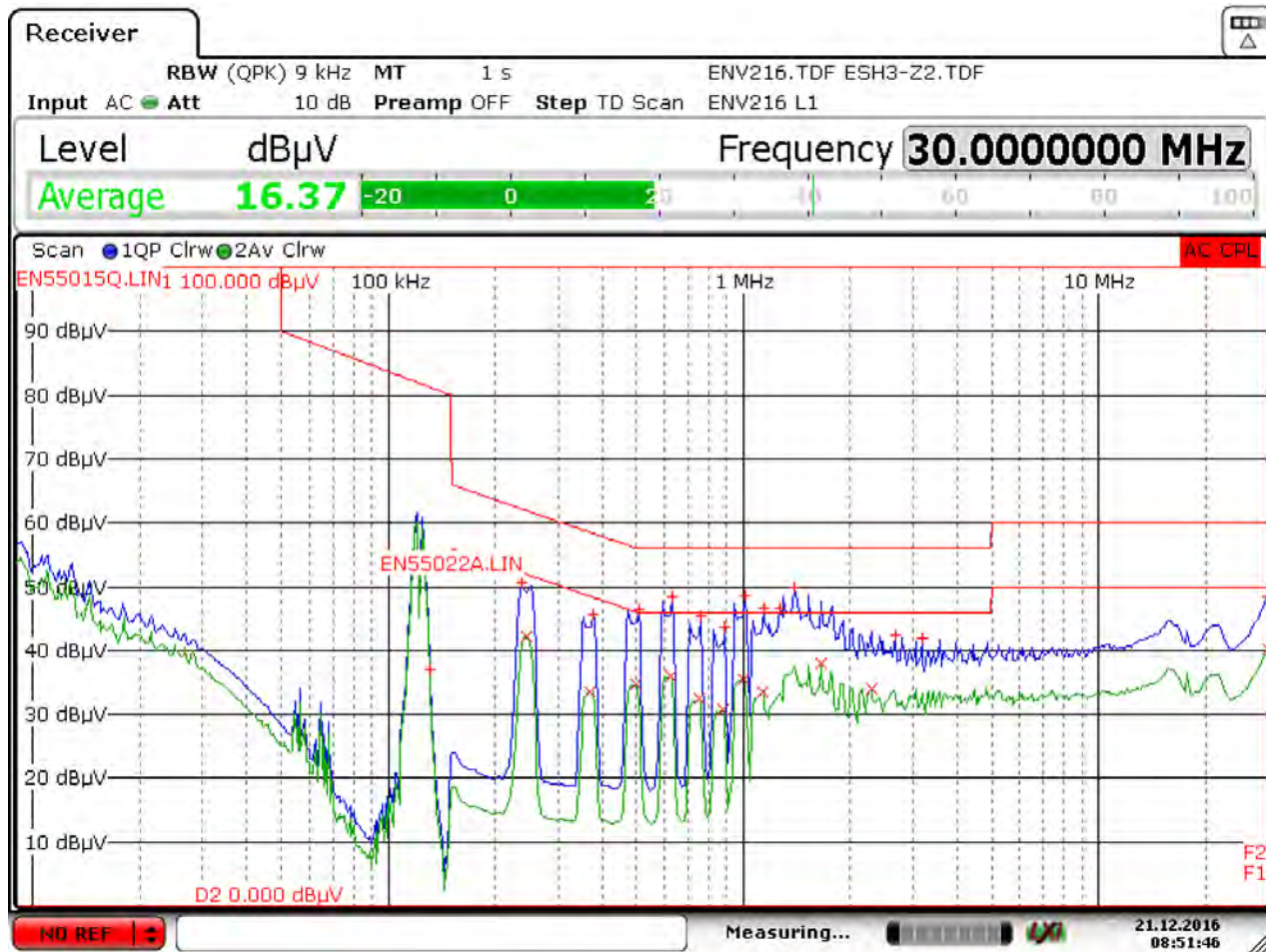

Figure 76 – Conducted EMI Test Set-up.

14.2 EMI Test Result



Date: 21.DEC.2016 08:51:46

Figure 77 – Conducted EMI QP Scan at 80 V LED Load, 115 VAC, 60 Hz, and EN55015 B Limits.

Trace/Detector	Frequency	Level dBµV	DeltaLimit
1 Quasi Peak	1.3988 MHz	49.99 L1	-6.01 dB
1 Quasi Peak	1.0163 MHz	48.65 L1	-7.35 dB
1 Quasi Peak	633.7500 kHz	48.33 L1	-7.67 dB
2 Average	1.6530 MHz	37.96 L1	-8.04 dB
1 Quasi Peak	1.1445 MHz	46.69 L1	-9.31 dB
1 Quasi Peak	1.2728 MHz	46.58 L1	-9.42 dB

Figure 78 – Conducted EMI Data at 115 VAC, 80 V LED Load.



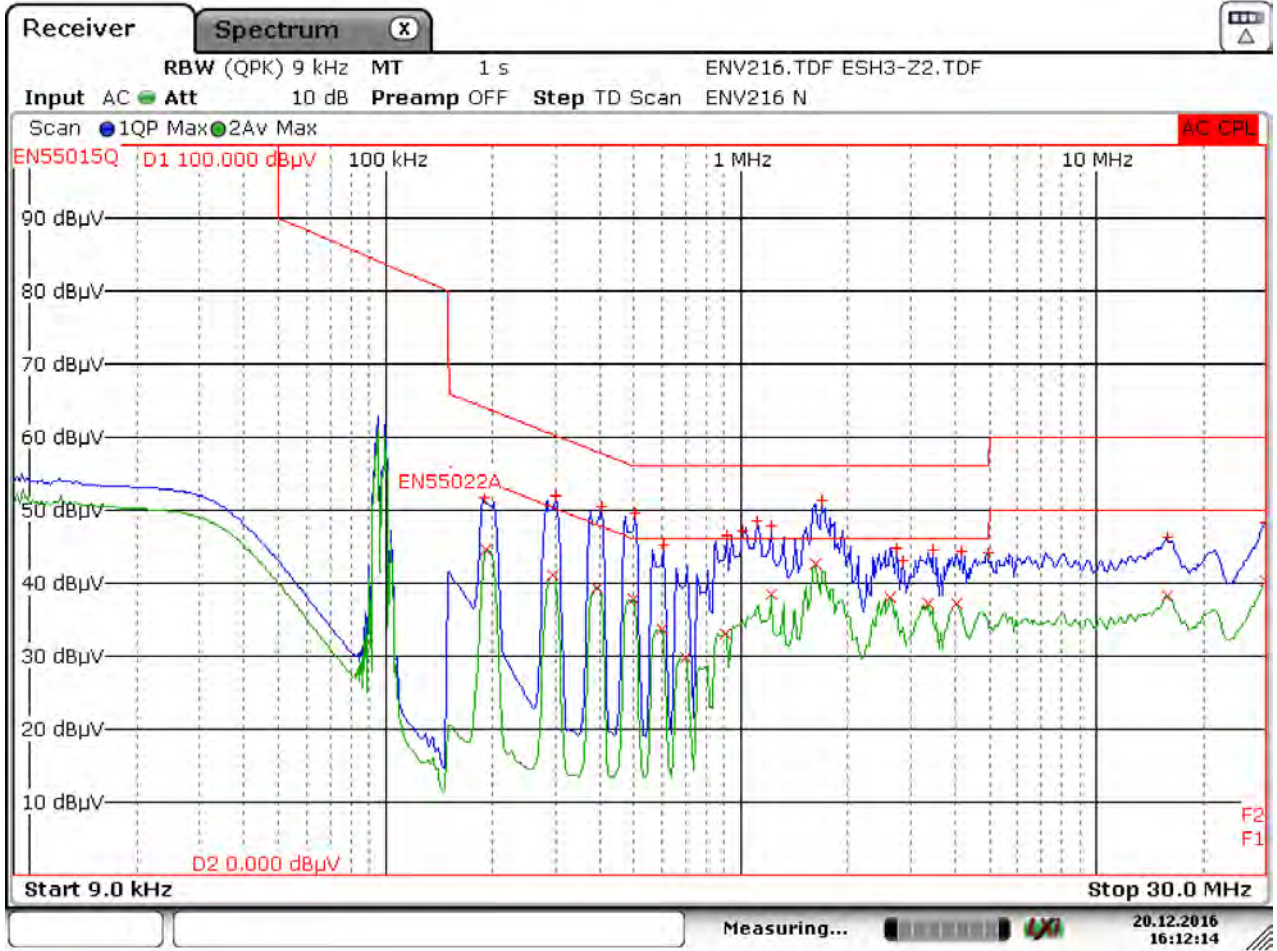

Date: 20.DEC.2016 16:12:14

Figure 79 – Conducted EMI QP Scan at 80 V LED Load, 230 VAC, 50 Hz, and EN55015 B Limits.

Trace/Detector	Frequency	Level dBµV	DeltaLimit
2 Average	1.6238 MHz	42.62 L1	-3.38 dB
1 Quasi Peak	1.6913 MHz	51.28 L1	-4.72 dB
1 Quasi Peak	505.5000 kHz	49.64 L1	-6.36 dB
1 Quasi Peak	404.2500 kHz	50.49 L1	-7.28 dB
1 Quasi Peak	1.1153 MHz	48.47 L1	-7.53 dB

Figure 80 – Conducted EMI Data at 230 VAC, 80 V LED Load.



15 Line Surge

The unit was subjected to ± 2500 V, 100 kHz ring wave and ± 1000 V differential surge using 10 strikes at each condition. A test failure was defined as a non-recoverable interruption of output requiring repair or recycling of input voltage.

Surge Level (V)	Input Voltage (VAC)	Injection Location	Injection Phase (°)	Test Result (Pass/Fail)
+1000	115/230	L to N	0	Pass
-1000	115/230	L to N	0	Pass
+1000	115/230	L to N	90	Pass
-1000	115/230	L to N	90	Pass

Surge Level (V)	Input Voltage (VAC)	Injection Location	Injection Phase (°)	Test Result (Pass/Fail)
+2500	115/230	L to N	0	Pass
-2500	115/230	L to N	0	Pass
+2500	115/230	L to N	90	Pass
-2500	115/230	L to N	90	Pass

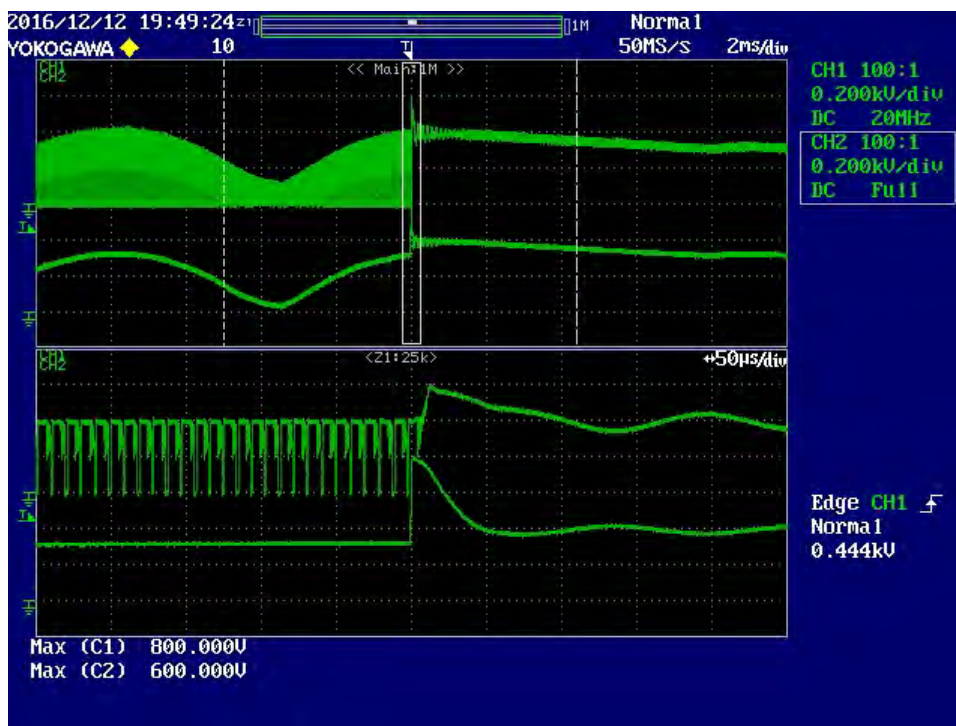

Figure 81 – +1000 V Differential Surge, 90° Phase Angle.
 V_{DRAIN} , 200 V / div., 2 ms / div.
 Peak V_{DRAIN} : 600 V.

16 Brown-in / Brown-out Test

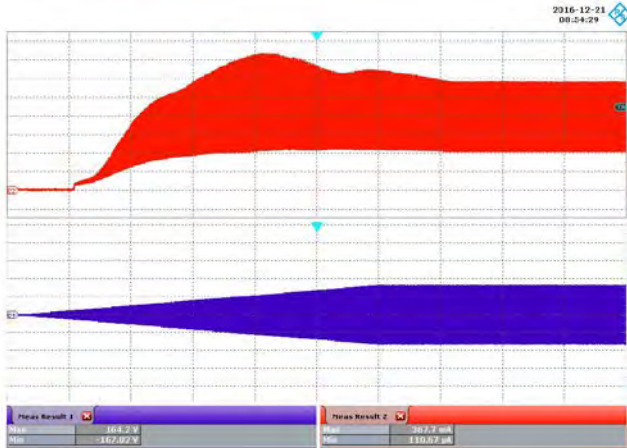

Figure 82 – 115 VAC Brown-in Test at 0.5 V / s.
 Ch1: I_{OUT} , 50 mA / div.
 Ch2: V_{IN} , 100 V / div.
 Time Scale: 40 s / div.

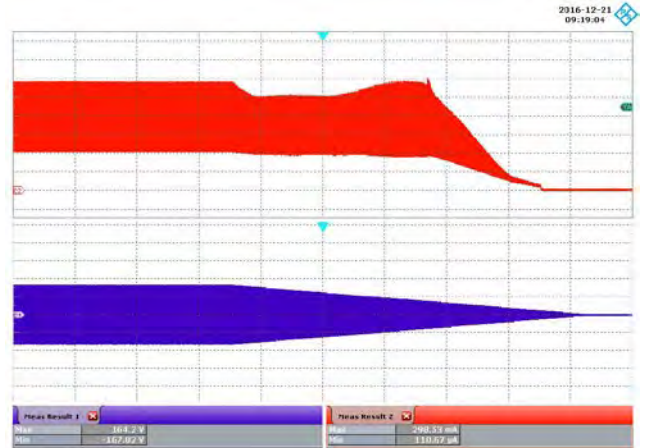

Figure 83 – 115 VAC Brown-out Test at 0.5 V / s.
 Ch1: I_{OUT} , 50 mA / div.
 Ch2: V_{IN} , 100 V / div.
 Time Scale: 20 s / div.

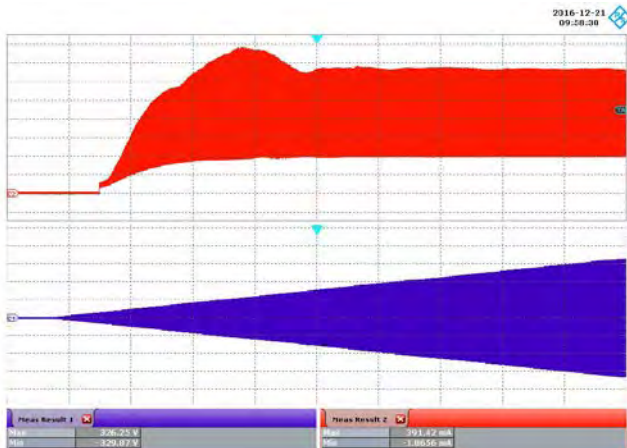

Figure 84 – 230 VAC Brown-in Test at 0.5 V / s.
 Ch1: I_{OUT} , 50 mA / div.
 Ch2: V_{IN} , 100 V / div.
 Time Scale: 50 s / div.

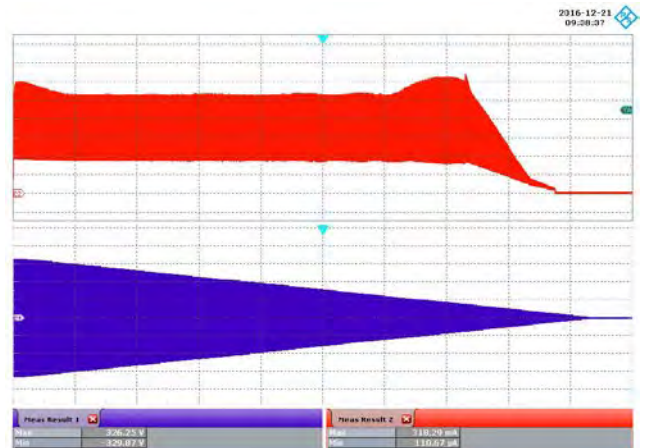

Figure 85 – 230 VAC Brown-out Test at 0.5 V / s.
 Ch1: I_{OUT} , 50 mA / div.
 Ch2: V_{IN} , 100 V / div.
 Time Scale: 50 s / div.

17 Revision History

Date	Author	Revision	Description and Changes	Reviewed
06-Feb-17	AM	1.0	Initial Release	Apps & Mktg



For the latest updates, visit our website: www.power.com

Power Integrations reserves the right to make changes to its products at any time to improve reliability or manufacturability. Power Integrations does not assume any liability arising from the use of any device or circuit described herein. POWER INTEGRATIONS MAKES NO WARRANTY HEREIN AND SPECIFICALLY DISCLAIMS ALL WARRANTIES INCLUDING, WITHOUT LIMITATION, THE IMPLIED WARRANTIES OF MERCHANTABILITY, FITNESS FOR A PARTICULAR PURPOSE, AND NON-INFRINGEMENT OF THIRD PARTY RIGHTS.

Patent Information

The products and applications illustrated herein (including transformer construction and circuits' external to the products) may be covered by one or more U.S. and foreign patents, or potentially by pending U.S. and foreign patent applications assigned to Power Integrations. A complete list of Power Integrations' patents may be found at www.power.com. Power Integrations grants its customers a license under certain patent rights as set forth at <http://www.power.com/ip.htm>.

The PI Logo, TOPSwitch, TinySwitch, LinkSwitch, LYTSwitch, InnoSwitch, DPA-Switch, PeakSwitch, CAPZero, SENZero, LinkZero, HiperPFS, HiperTFS, HiperLCS, Qspeed, EcoSmart, Clampless, E-Shield, Filterfuse, FluxLink, StackFET, PI Expert and PI FACTS are trademarks of Power Integrations, Inc. Other trademarks are property of their respective companies. ©Copyright 2015 Power Integrations, Inc.

Power Integrations Worldwide Sales Support Locations**WORLD HEADQUARTERS**

5245 Hellyer Avenue
San Jose, CA 95138, USA.
Main: +1-408-414-9200
Customer Service:
Phone: +1-408-414-9665
Fax: +1-408-414-9765
e-mail: usasales@power.com

GERMANY

Lindwurmstrasse 114
80337, Munich
Germany
Phone: +49-895-527-39110
Fax: +49-895-527-39200
e-mail: eurosales@power.com

JAPAN

Kosei Dai-3 Building
2-12-11, Shin-Yokohama,
Kohoku-ku, Yokohama-shi,
Kanagawa 222-0033
Japan
Phone: +81-45-471-1021
Fax: +81-45-471-3717
e-mail: japansales@power.com

TAIWAN

5F, No. 318, Nei Hu Rd.,
Sec. 1
Nei Hu District
Taipei 11493, Taiwan R.O.C.
Phone: +886-2-2659-4570
Fax: +886-2-2659-4550
e-mail:
taiwansales@power.com

CHINA (SHANGHAI)

Rm 2410, Charity Plaza, No. 88,
North Caoxi Road,
Shanghai, PRC 200030
Phone: +86-21-6354-6323
Fax: +86-21-6354-6325
e-mail: chinasales@power.com

INDIA

#1, 14th Main Road
Vasanthanagar
Bangalore-560052
India
Phone: +91-80-4113-8020
Fax: +91-80-4113-8023
e-mail: indiasales@power.com

KOREA

RM 602, 6FL
Korea City Air Terminal B/D,
159-6
Samsung-Dong, Kangnam-Gu,
Seoul, 135-728 Korea
Phone: +82-2-2016-6610
Fax: +82-2-2016-6630
e-mail: koreasales@power.com

UK

Cambridge Semiconductor,
a Power Integrations company
Westbrook Centre, Block 5,
2nd Floor
Milton Road
Cambridge CB4 1YG
Phone: +44 (0) 1223-446483
e-mail: eurosales@power.com

CHINA (SHENZHEN)

17/F, Hivac Building, No. 2, Keji
Nan 8th Road, Nanshan District,
Shenzhen, China, 518057
Phone: +86-755-8672-8689
Fax: +86-755-8672-8690
e-mail: chinasales@power.com

ITALY

Via Milanese 20, 3rd. Fl.
20099 Sesto San Giovanni (MI)
Italy
Phone: +39-024-550-8701
Fax: +39-028-928-6009
e-mail: eurosales@power.com

SINGAPORE

51 Newton Road,
#19-01/05 Goldhill Plaza
Singapore, 308900
Phone: +65-6358-2160
Fax: +65-6358-2015
e-mail: singaporesales@power.com

